

INSTALLATION GUIDE

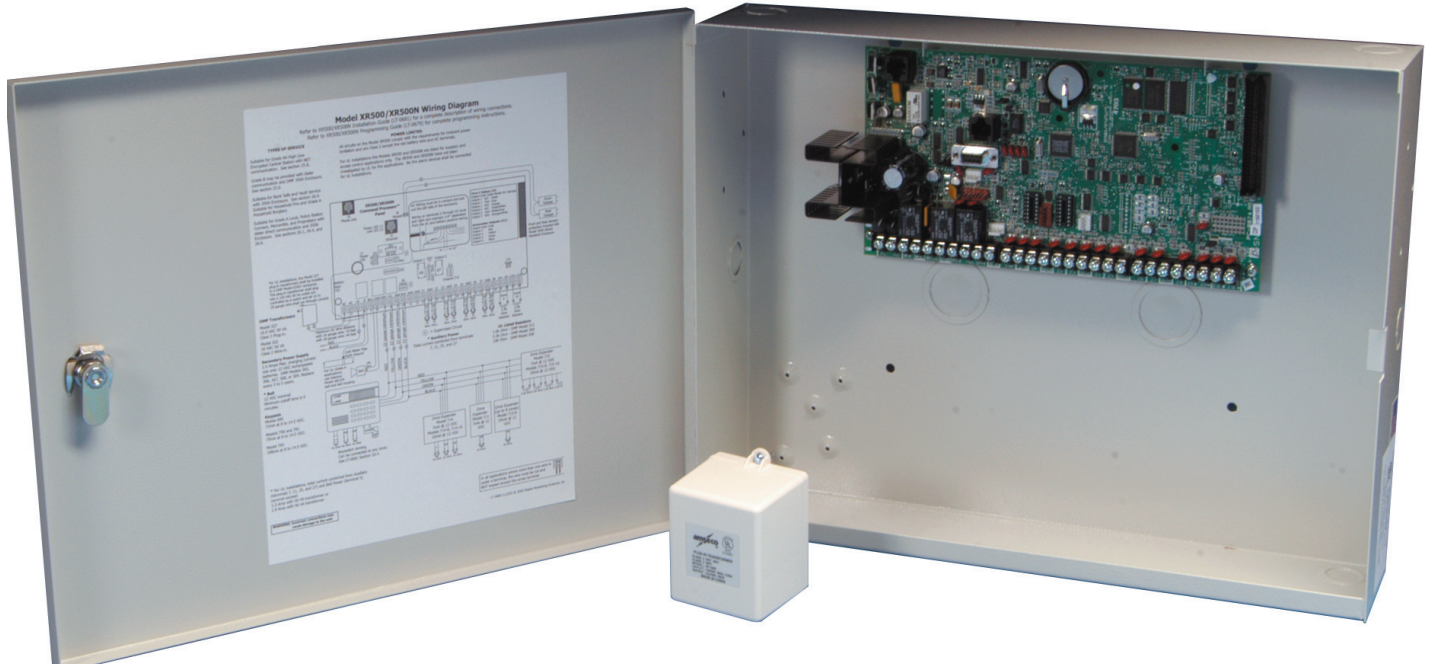

XR500 SERIES ACCESS CONTROL COMMAND PROCESSOR™ PANEL

MODEL XR500, XR500N, XR500E COMMAND PROCESSOR INSTALLATION GUIDE

FCC NOTICE

This equipment generates and uses radio frequency energy and, if not installed and used properly in strict accordance with the manufacturer's instructions, may cause interference with radio and television reception. It has been type tested and found to comply with the limits for a Class A computing device in accordance with the specification in Subpart J of Part 15 of FCC Rules, which are designed to provide reasonable protection against such interference in a residential installation. If this equipment does cause interference to radio or television reception, which can be determined by turning the equipment off and on, the installer is encouraged to try to correct the interference by one or more of the following measures:

- Reorient the receiving antenna

- Relocate the computer with respect to the receiver

- Move the computer away from the receiver

- Plug the compute into a different outlet so that computer and receiver are on different branch circuits

If necessary, the installer should consult the dealer or an experienced radio/television technician for additional suggestions. The installer may find the following booklet, prepared by the Federal Communications Commission, helpful:

"How to identify and Resolve Radio-TV Interference Problems."

This booklet is available from the U.S. Government Printing Office, Washington D.C. 20402

Stock No. 004-000-00345-4

© 2004 Digital Monitoring Products, Inc.

Information furnished by DMP is believed to be accurate and reliable.

This information is subject to change without notice.

Revisions to This Document

Product Specifications

1.1	Power Supply	1
1.2	Communication	1
1.3	Panel Zones	1
1.4	Keypad Bus	1
1.5	LX-Bus™	1
1.6	Outputs	1
1.7	Enclosure Specifications	1

Panel Features

2.1	Description.....	2
2.2	Zone Expansion	2
2.3	Output Expansion	2
2.4	Central Station Communication.....	2
2.5	Encrypted Communications (XR500N/XR500E only).....	3
2.6	Before you Begin	3
2.7	About this Guide.....	3
2.8	How to Use this Guide	3

System Components

3.1	Description.....	3
3.2	Wiring Diagram	4
3.3	Lightning Protection.....	5
3.4	Accessory Devices	5
3.5	Notification Appliances	6

Installation

4.1	Mounting the Enclosure.....	7
4.2	Mounting Keypads and Zone Expansion Modules.....	8
4.3	Connecting LX-Bus and Keypad Bus Devices	9

Primary Power Supply

5.1	AC Terminals 1 and 2	9
5.2	Transformer Types	9

Secondary Power Supply

6.1	Battery Terminals 3 and 4	10
6.2	Earth Ground	10
6.3	Battery Only Restart	10
6.4	Battery Replacement Period	10
6.5	Discharge/Recharge.....	10
6.6	Battery Supervision.....	10
6.7	Battery Cutoff.....	10
6.8	XR500 Series Power Requirements.....	11
6.9	Standby Battery Selection	13

Bell Output

7.1	Terminals 5 and 6	14
-----	-------------------------	----

Keypad Bus

8.1	Description.....	14
8.2	Terminal 7 - RED	14
8.3	Terminal 8 - YELLOW	14
8.4	Terminal 9 - GREEN	14
8.5	Terminal 10 - BLACK	14
8.6	J8 Programming Connection	14
8.7	OVC LED.....	14

TABLE OF CONTENTS

Smoke and Glassbreak Detector Output	
9.1	Terminals 11 and 12 14
9.2	Current Rating..... 14
Protection Zones	
10.1	Terminals 13–24 15
10.2	Operational Parameters..... 15
10.3	Zone Response Time..... 15
10.4	Keyswitch Arming Zone 15
Powered Zones for 2-Wire Smoke Detectors	
11.1	Terminals 25–26 and 27–28 15
11.2	Compatible 2-Wire Smoke Detector Chart..... 16
Dry Contact Relay Outputs	
12.1	Description..... 17
12.2	Contact Rating 17
12.3	Model 431 Output Harness Wiring..... 17
Annunciator Outputs	
13.1	Description..... 17
13.2	Model 300 Harness Wiring..... 17
J23 6-Pin Header	
14.1	Description..... 18
J22 LX-Bus Expansion Connector	
15.1	Description..... 18
15.2	J22 LX-Bus Header 18
15.3	LX-Bus Interface Cards..... 18
15.4	LX-Bus LEDs..... 19
15.5	OVC LED..... 19
J21 Serial Connector	
16.1	Description..... 19
16.2	Serial Connector LEDs..... 19
J1 Ethernet Connector (XR500N/XR500E only)	
17.1	Description 19
17.2	Ethernet LEDs 19
J3 Telephone RJ Connector	
18.1	FCC Registration 19
18.2	Description..... 20
18.3	J10 893A Connector..... 20
18.4	Notification 20
18.5	Phone Line Monitor 20
Reset and Tamper Headers	
19.1	J16 Reset Header 21
19.2	J4 Tamper Header 21
Universal UL Burglary Specifications	
20.1	Introduction 22
20.2	Wiring 22
20.3	Control Outside of Protected Area 22
20.4	Police Station Phone Numbers 22
20.5	Bypass Reports..... 22
20.6	System Maintenance 22
20.7	UL Listed Receivers..... 22
20.8	Power Supply Supervision 22

TABLE OF CONTENTS

Area Information

21.1	Ownership	23
21.2	Annunciation	23
21.3	Trouble Display.....	23
21.4	Closing Wait.....	23
21.5	Local Bell Supervision	23

UL 1023 Specifications

22.1	Audible Devices.....	23
22.2	Auxiliary Circuits.....	23
22.3	Bell Cutoff.....	23
22.4	Entry Delay	23
22.5	Exit Delay	23
22.6	Weekly Test.....	23

UL 1610 AND 1076 Specifications

23.1	Opening/Closing Reports.....	24
23.2	Closing Wait.....	24
23.3	Entry Delay	24
23.4	Exit Delay	24
23.5	Proprietary Dialer	24
23.6	Grade B Central Station.....	24
23.7	Bell Cutoff.....	24
23.8	AA High Line Network Security	24

UL 1635 Specifications

24.1	System Trouble Display	25
24.2	Digital Dialer Telephone Number.....	25
24.3	Test Time.....	25
24.4	Closing Wait.....	25

UL 365 Specifications

25.1	System Trouble Display	25
25.2	Entry Delay	25
25.3	Exit Delay	25
25.4	Grade A Bell.....	25
25.5	Bell Cutoff.....	25
25.6	Automatic Bell Test	25
25.7	Line Security for Police Connect.....	25
25.8	AA High Line Network Security	25

UL 609 Specifications

26.1	Grade A Mercantile	26
26.2	Entry Delay	26
26.3	Exit Delay	26
26.4	Mercantile Safe and Vault.....	26
26.5	Grade A Bell.....	26
26.6	Bank Safe and Vault (XR500N/XR500E only).....	26

UL 294 Specifications

27.1	Panel Designation.....	26
27.2	Compatible Devices	26
27.3	Tamper Protection	26

TABLE OF CONTENTS

Universal UL and NFPA Fire Alarm Specifications

28.1	Introduction	27
28.2	Wiring	27
28.3	Transformer	27
28.4	End-of-Line Resistor	27
28.5	System Trouble Display	27
28.6	Fire Display	27
28.7	Police Station Phone Number	27
28.8	System Maintenance	27
28.9	Audible Alarm	27
28.10	Fire Zone Programming	27
28.11	Style D Zones	27
28.12	Video Option	27
28.13	UL Listed Receivers	27

UL 864 NFPA 72 (Chapter 9) Specifications

29.1	Zone Restoral Reports	28
29.2	Power Fail Delay	28
29.3	Sprinkler Supervisory	28
29.4	DACT Systems	28
29.5	Local Protective Signaling Systems	28
29.6	Remote Station Protective Signaling Systems	28
29.7	Fire Protective Signaling Systems using Internet/Intranet Networks	28

UL 985 NFPA 72 (Chapter 2) Specifications

30.1	Bell Output Definition	29
30.2	Audible Devices	29
30.3	Auxiliary Circuits	29
30.4	Bell Cutoff	29

California State Fire Marshal Specifications

31.1	Bell Output Definition	29
------	------------------------------	----

Wiring Diagrams

32.1	Multiple Notification Circuit Modules	30
32.2	Multiple Notification Circuit Modules for Zoned Annunciation	31
32.3	Dual Style D Zone Module Installation	32
32.4	Cellular Backup Installation for Derived Channel Burglary	33
32.5	Rothenbuhler 5110 High Security Bell Wiring	34
32.6	LX-Bus™ Module Connection	35
32.7	Model 860 Relay Module Connection	36
	Access Control Devices	38

OPERATING INSTRUCTIONS MODEL XR500, XR500N, XR500E PANELS

	Listings and Approvals	38
--	------------------------------	----

This page intentionally left blank.

Revisions to This Document

This section explains the changes that were made to this document during this revision. This section lists the date the change was made, the section number and heading, and a quick summary of the change.

Date	Section Number and Heading	Summary of Changes
12/04	Section 1.7 Enclosure Specifications Sections 3.2 and 7.1 Section 4.1 Mounting the Enclosure Back Cover	Added 341 and 352 Enclosure information. Clarified EOL resistor information. Added 341 and 352P/352S Enclosures as options. Removed Operating Instructions (LT-0352). Expanded Listings and Approvals and added ULC Listings.
11/04	Section 3.2 Wiring Diagram Sections 3.4 Accessory Devices Section 4.3 Connecting Bus Devices Section 6.8 Power Requirements Section 6.9 Standby Battery Selection Section 15.2 J22 LX-Bus Header Section 16.1 J21 Serial Connector Section 26.4 Mercantile Safe and Vault Section 26.6 Bank Safe and Vault Access Control Devices	Added new Thinline keypad models. Added new Thinline keypad models. Clarified J22 on-board LX-Bus information. Added 734 Module and Thinline keypad models. Added notes regarding transformers and battery recharge time. Added LX-Bus wiring information and changed Host Log Reports to PC Log Reports. Changed Host Log Reports to PC Log Reports. Replaced specific models with XR500 Series. Revised cross-reference information. Added Thinline keypad models.
4/04	Entire Document Entire Document Section 2.5 Encrypted Communications Section 7.1 Terminals 5 and 6	Added XR500E model information where applicable. Changed XR500/XR500N to XR500 Series. Added Encrypted Communications information for XR500N/XR500E only. Note: Subsequent numbers in the section were affected. Clarified bell output operation.
2/04	Sections 3.5 and 6.8 Section 17 J1 Ethernet 32.4 Cellular Backup Installation for Derived Channel Burglary	Added keypad models 690F, 790F, and 693. Added/revised current draw information. Revised incorrect drawing and text. Revised drawing and added STU connection text.

Product Specifications

1.1 Power Supply

- Transformer Input: Model 327, plug-in – Primary input: 120 VAC, 60 Hz, Secondary output: 16.5 VAC 50 VA
 Model 322, wire-in – Primary input: 120 VAC, 60 Hz, Secondary output: 16 VAC 56 VA
- Standby Battery: 12 VDC, 1.0 Amps Max. charging current
 Models 365, 366, 367, 368, or 369
 Replace every 3 to 5 years
- * Auxiliary: 12 VDC output at 1.5 Amp Max
- * Bell Output: 12 VDC at 1.5 Amp Max

Note: The combined Auxiliary and Bell outputs total cannot exceed 3 Amps with a 50 VA or 56 VA Transformer. All circuits are inherent Power Limited except the red battery wire and AC terminal.

- * For UL installations, the total current combined from Auxiliary and Bell Power cannot exceed:
 1.3 Amps with a 50 VA transformer, 1.0 Amp Max for Auxiliary Power
 1.9 Amps with a 56 VA transformer, 1.0 Amp Max for Auxiliary Power and 1.5 Amp Max for Bell

1.2 Communication

- Built-in network communication to DMP Model SCS-1/SCS-1R Receivers (XR500N/XR500E only)
- Built-in encrypted communication to iCOM-E™ Encrypted Network Alarm Router (XR500E only)
- Built-in dialer communication to DMP Model SCS-1/SCS-1R Receivers
- Built-in Contact ID communication to non-DMP receivers
- Optional 893A Dual Phone Line Module with phone line supervision
- Can operate as a local panel

1.3 Panel Zones

- Eight 1k Ohm EOL burglary zones (zones 1 to 8)
- Two 3.3k Ohm EOL powered zone with reset (zones 9 and 10)

1.4 Keypad Bus

You can connect up to 16 of the following supervised keypads and expansion modules to the keypad bus:

- Alphanumeric keypads
- Single-zone detectors
- Four- and/or single-zone expansion modules
- Access control modules

1.5 LX-Bus™

You can connect the following devices to the LX-Bus™ provided on the panel or by the DMP 481, 462N, 462P, 462FM, and 472 Interface Cards up to the maximum number of LX-Bus™ addresses. See Accessory Devices in section 3.4.

- Four- and/or single-zone expansion modules
- Relay output expansion modules
- Single-zone detectors
- Graphic annunciator modules

1.6 Outputs

The XR500 Series provide two Single Pole, Double Throw (SPDT) relay outputs which require the installation of two Model 305 relays, each rated 1 Amp at 30 VDC resistive (power limited sources only). A Model 431 Output Harness is required to use these outputs.

The XR500 Series panels also provide four open collector outputs rated for 50mA each. The open collector outputs provide ground connection for a positive voltage source. A Model 300 Output Harness is required to use these outputs.

1.7 Enclosure Specifications

The XR500 Series panels are shipped in an enclosure with a transformer, End-of-Line resistors, battery leads, user's guide, and programming sheets.

Model 350A Enclosure

- Enclosure size: 17.5" W x 13.5" H x 3.75" D
- Color: Gray (G)
- Construction: 18-gauge with 16-gauge door

Model 350 Enclosure

- Enclosure size: 17.5" W x 13.5" H x 3.5" D
- Color: Gray (G) or Red (R)
- Construction: 18-gauge, cold-rolled steel

Model 352P Enclosure

- Enclosure size: 14.5" W x 32.0" H x 4.0" D
- Color: Gray (G)
- Construction: 16-gauge, cold-rolled steel

Model 341 Enclosure

- Enclosure size: 12.75" W x 6.55" H x 2.9" D
- Color: Gray (G)
- Construction: 20-gauge, cold-rolled steel

Panel Features

2.1 Description

The DMP XR500 Series Command Processor™ Panel is a versatile 12 VDC, combined access control, burglary, and fire communicator panel with battery backup. The XR500 Series provides eight on-board burglary zones and two on-board 12 VDC Class B powered zones. The powered zones have a reset capability to provide for 2-wire smoke detectors, relays, or other latching devices. The XR500 Series can communicate to one or two DMP SCS-1/SCS-1R Receivers using digital dialer or network communication, or to non-DMP receivers using the Contact ID format.

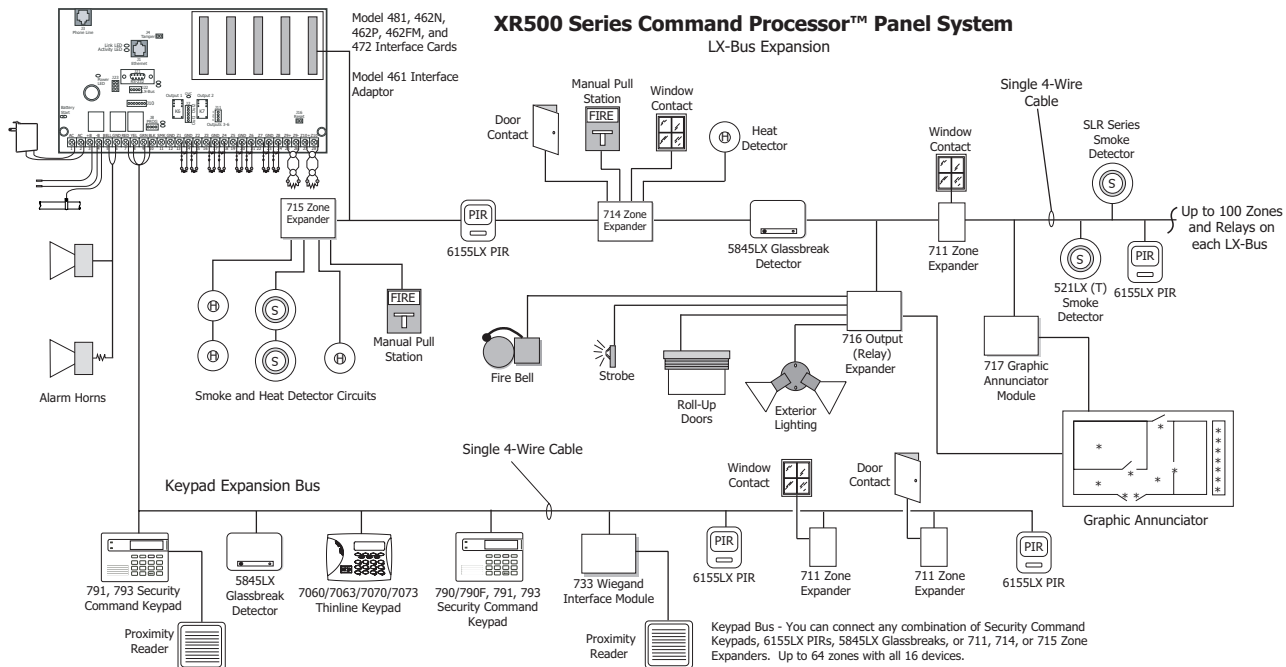

Figure 1: Typical XR500 Series System Configuration

2.2 Zone Expansion

Up to 574 additional zones are available on the XR500 Series using DMP LCD keypad remote zone capability and zone expansion modules. The panel keypad data bus supports up to sixteen supervised device addresses with each address supporting up to four programmable expansion zones.

Up to 500 zones are available using the on board LX-Bus, Model 461 Interface Adaptor with 481, 462N, 462P, 462FM, or 472 Interface Cards, and any combination of single, four, eight, or 16-zone expansion modules and single-zone LX-Bus™ detectors.

Note: Do not use shielded wire for LX-Bus or Keypad Bus circuits.

2.3 Output Expansion

In addition to the two SPDT relays and four open collector outputs on the XR500 Series, you can also connect up to 25 Model 716 Output Expansion Modules to each LX-Bus. These modules can provide an additional 500 programmable SPDT relays.

The XR500 Series provides 100 Output Schedules you can use for programming the 716 to perform a variety of annunciation and control functions. You can also assign the 716 outputs to any panel Output Options such as Fire Alarm, Communication Fail, or Phone Trouble Outputs. Refer to the 716 Installation Guide (LT-0183).

The LX-Bus™ also supports the Model 717 Graphic Annunciator Module. Each 717 module supplies 20 switched ground outputs that follow the state of their assigned zones. Refer to the 717 Installation Guide (LT-0235) for more information.

2.4 Central Station Communication

You can program the XR500 Series panel for local annunciation only, or for reporting to one or two DMP SCS-1/SCS-1R Receivers using digital dialer or network communication. The panel can also communicate to non-DMP receivers using the Contact ID communication format. The XR500 Series connects at the premises to a standard RJ31X or RJ38X telephone jack. Use the DMP 893A Dual Phone Line Module when connecting the XR500 Series panel to two separate phone lines in fire or burglary applications.

2.5 Encrypted Communications (XR500N/XR500E only)

An XR500E panel communicates using AES Rijndael encryption. If you currently have an XR500N panel installed, you may contact DMP Customer Service with the panel serial number. The serial number(s) should be sent in writing via e-mail or fax. A separate feature key is sent for each panel to activate encrypted communications using the Feature Upgrade process. Encrypted communication cannot be enabled on a standard XR500 panel. For more information on the Feature Upgrade process see Section 19 in the XR500 Series Programming Guide (LT-0679).

2.6 Before you Begin

Before installing the XR500 Series, we recommend you read through the entire contents of this guide. Familiarize yourself with the features of the panel and the key points to remember during the installation. Be sure to read and understand all of the caution statements printed in bold italics.

2.7 About this Guide

The information in this guide is organized into five sections: Table of Contents, Introduction, Installation, Compliance, and System Diagrams.

- The Table of Contents at the front lists the headings and subheadings used throughout each section of the guide. To the right of each heading is the section number where the information can be found.
- The Introduction section provides an overview of the various components that go into an XR500 Series system and provides diagrams of typical system configurations. This section describes the panel, keypads, zone expansion modules, and accessory modules and provides details on how they operate together in the system.
- The Installation section begins with mounting instructions for the enclosure and continues with detailed XR500 Series panel operational characteristics.
- The Compliance section describes the various regulations the XR500 Series complies with, such as UL.
- The System Diagrams illustrate different ways to wire the XR500 Series to a variety of modules.

Caution Notes

Throughout this guide you will see caution notes containing information you need to know when installing the panel. These cautions are indicated with a yield sign. Whenever you see a caution note, make sure you completely read and understand its information. Failing to follow the caution note can cause damage to the equipment or improper operation of one or more components in the system. See the example shown below.



Always ground the panel before applying power to any devices: The XR500 Series must be properly grounded before connecting any devices or applying power to the panel. Proper grounding protects against Electrostatic Discharge (ESD) that can damage system components.

2.8 How to Use this Guide

To locate information about the XR500 Series installation, first go to the Table of Contents at the front of this guide. Find the subject heading that best describes the information you need and turn to the section number shown to the right of the heading.

The text that follows the heading is written to provide as much information about the subject as possible. If you cannot find the information you need under that heading, try scanning through a few of the headings before and after and reading the text under those that sound similar.

System Components

3.1 Description

The DMP XR500 Series system is made up of an alarm panel with a built-in communicator, an enclosure, battery, one 16.5 VAC transformer, and keypads. You can use up to sixteen supervised 32-character LCD keypads; network communications and expansion interface cards; zone and output expansion modules; and initiating and indicating circuit modules. You can also connect auxiliary devices to the panel's output relays to expand the basic system control capability. Combined current requirements of additional modules may require an auxiliary power supply. Refer to section 6.8 in this guide when calculating power requirements.

INTRODUCTION

3.2 Wiring Diagram

The XR500 Series diagram below shows some of the accessory modules you can connect for use in various applications. A brief description of each module follows in section 3.4.

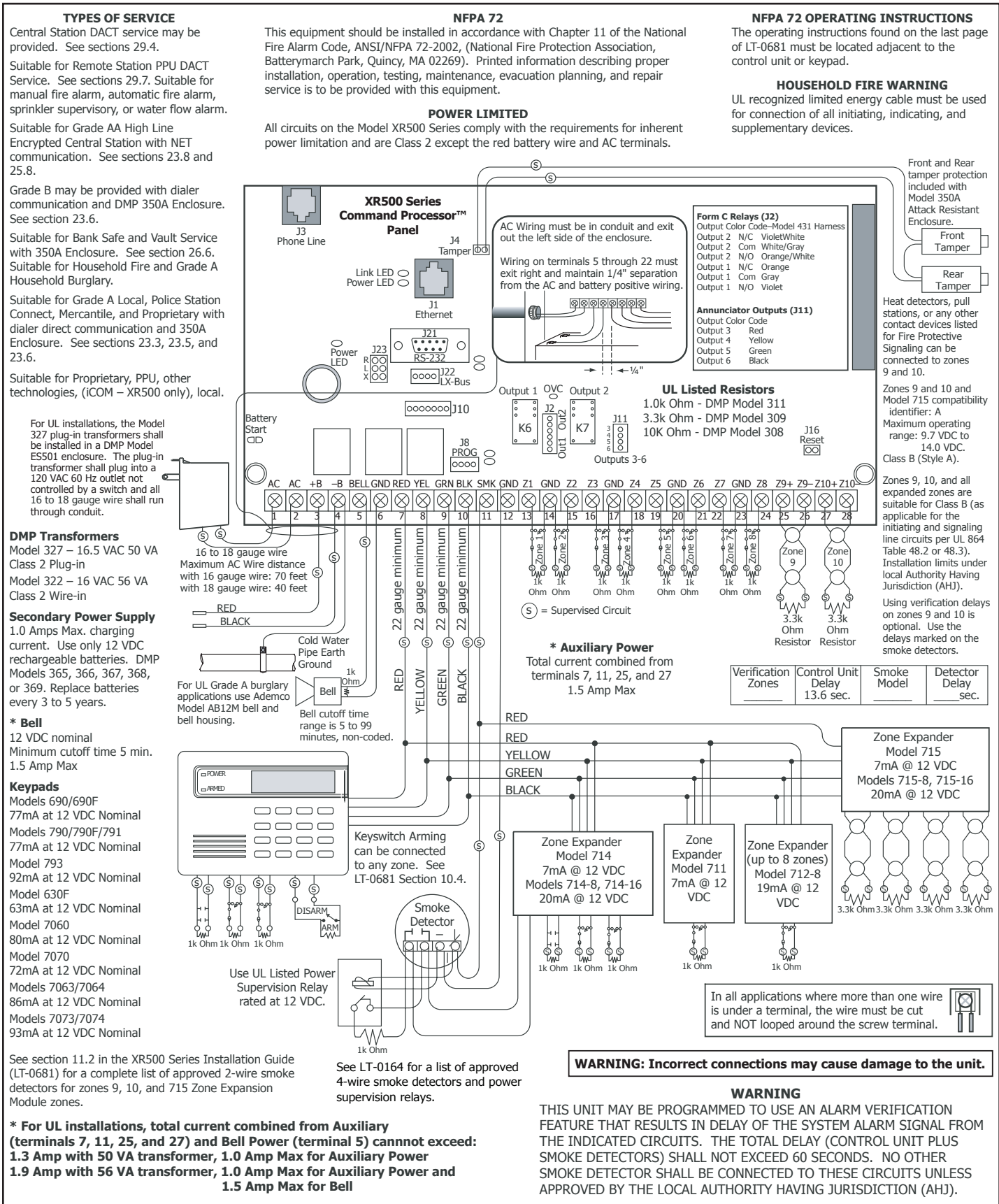

Figure 2: XR500 Series Wiring Diagram

3.3 Lightning Protection

Metal Oxide Varistors and Transient Voltage Suppressors help protect against voltage surges on XR500 Series input and output circuits. Additional surge protection is available by installing the DMP 370 or 370RJ Lightning Suppressors.

3.4 Accessory Devices

Interface Adaptor and Interface Cards	
461 Interface Adaptor Card	Allows you to connect two or more expansion interface cards to the XR500 Series panel. The 461 is an expansion mother board that plugs into the panel J6 Interface Connector and is required when using two or more Interface Cards. Use combinations of Interface Cards for expanding zones, network interfacing, local printing, and connecting wireless devices. Requires Model 350, or 350A Enclosure.
462N Network Interface Card	Allows you to connect the XR500 Series to any compatible data network and use its communication capability in place of standard dial out telephone lines. The 462N also provides an LX-Bus™ for connecting zone and output expansion modules to the panel. The 462N is listed for Grade AA Burglary communication and supplementary signaling.
462P Printer Interface Card	Allows you to connect the XR500 Series to any compatible serial printer providing the user with real-time event recording. The 462P also provides an LX-Bus™ for connecting zone and output expansion modules.
* 462FM 9600 Baud Modem	Allows you to remote-connect to the panel over telephone lines and upload/download at 9600 baud using a standard Hayes compatible modem. The card shares the phone line with the panel and provides 100 LX-Bus zones and/or outputs.
481 Expansion Interface Card	Provides one LX-Bus for connecting up to 100 zone and output expansion modules.
472 Wireless Interface Card	Provides one LX-Bus for connecting up to 200 wireless or hardwired zone expansion modules.
Zone and Output Expansion Modules	
710/710F Bus Splitter/Repeater	Allows you to increase keypad or LX-Bus™ wiring distance to 2500 feet. Model 710F is for 24 VDC applications.
711/711E Single Point Zone Expanders	Provides one Class B zone for connecting burglary devices.
714, 714-8, 714-16 Zone Expanders	Provides Class B zones for connecting burglary and non-powered fire devices.
712-8 Zone Expander	Provides Class B zones for connecting burglary devices.
715, 715-8, 715-16 Zone Expanders	Provides 12 VDC Class B powered zones for connecting smoke detectors, glassbreak detectors, and other 2- or 4-wire devices.
725 Zone Expanders	Provides 24 VDC Class B powered zones for connecting smoke detectors, glassbreak detectors, and other 2- or 4-wire devices. Requires 710F Bus Splitter/Repeater.
716 Output Expander	Provides four Form C relays (SPDT) and four switched grounds (open collector) for use in a variety of remote annunciation and control applications.
717 Graphic Annunciator Module	Provides 20 zone following annunciator outputs (open collector) for use in a variety of remote annunciation and control applications for use on the keypad bus only.
Indicating and Initiating Devices	
865 Supervised Style Y or Z Notification Circuit Module	Provides supervised alarm current when using the XR500 Series panel bell output and up to 5 Amps at 12 or 24 VDC when using a listed auxiliary power supply. The 865 can supervise 2-wire Style Y or Z circuits for ground faults, opens, shorts, and shorts with individual LED annunciation.
866 Notification Circuit Module	Provides supervised alarm current using the XR500 Series panel bell output and up to 5 Amps at 12 or 24 VDC when using a listed auxiliary power supply. The 866 can supervise Style W circuits for opens and shorts.
867 Style W LX-Bus Notification Circuit Module	Provides supervised alarm current using the XR500 Series panel bell output and up to 5 Amps at 12 or 24 VDC when using a listed auxiliary power supply. The 867 connects to the XR500 Series panel LX-Bus™ and provides one 2-wire Style W notification circuit for ground fault, open, and short conditions. Individual Bell Relay addresses Bell Ring styles.
869 Dual Style D Initiating Module	Provides two Style D, 4-wire initiating zones for connecting waterflow switches and other non-powered fire and burglary devices.
Accessory Modules and Keypads	
893A Dual Phone Line Module	Allows you to supervise two standard phone lines connected to an XR500 Series panel. The 893A module monitors the main and backup phone lines for a sustained voltage drop and alerts users when the phone line is bad.
* ePAD™ Virtual Keypads	Allows users to control the security system from any computer in the world using the Internet.
iCOM™ Network Alarm Router	Allows the XR500 panel to send signals through the Internet/Ethernet.
iCOM-E™ High-Security Network Alarm Router	Allow the XR500 panel to send encrypted signals through the Internet/Ethernet. For use when the Advanced Encryption Standard (AES) Rijndael Encryption Algorithm is required. The iCOM-E is NIST certified.
LCD keypads	Allows you to control the panel from various remote locations. Connect up to sixteen supervised Model 690/690F, 790/790F, 791, or 793 Security Command® keypads or Model 7060, 7063, 7064, or 7070, 7073, or 7074 Thinline keypads to the keypad bus using terminals 7, 8, 9, and 10.
Addressable Smoke Detectors	
521LX SLRLX	Single-zone, addressable module conventional smoke/smoke heat detectors that connect to the LX-Bus. Includes remote maintenance reporting, drift compensation, and multi-criteria detection.
* These devices have not been investigated by UL and shall not be used in UL installations.	

INTRODUCTION

3.5 Notification Appliances

The following table indicates the approved notification appliances that can be used with the XR500 Series system.

DMP Part Number	Description	Wheelock Model No.	12V
802	Multi-tone Horn	MT-12/24	x
803	Standard Horn	NH-12/24	x
806-6	Bell, 6 inch	MB-G6-12	x
806-10	Bell, 10 inch	MB-G10-12	x
821	Strobe, 15/75 candela	RSS-121575W-F	x
822	Strobe, w/retrofit plate	RSSP-121575W-F	x
823	Horn Strobe, 15/75 candela	NS-121575W-F	x
831	Sync Module, Single circuit,	SM-12/24-R	x
832	Sync Module, Dual circuit	DM-12/24-R	x

Installation

4.1 Mounting the Enclosure

The metal enclosure for the XR500 Series must be mounted in a secure, dry place to protect the panel from damage due to tampering or the elements. It is not necessary to remove the XR500 Series PCB when installing the enclosure. Figure 3 shows the mounting hole locations for both the Model 350/350A Enclosures. Figure 4 shows the Model 341 Small Enclosure. Figure 5 shows the Model 352P panel cabinet and 352S shelf cabinet for multiple batteries.

Note: When using the XR500 Series panel for UL Listed applications, use the Model 350, 349, 341, 342, or 352S enclosure for standby batteries. When using the 352P or 352S in UL listed applications, the enclosure must be surface mounted on the wall.

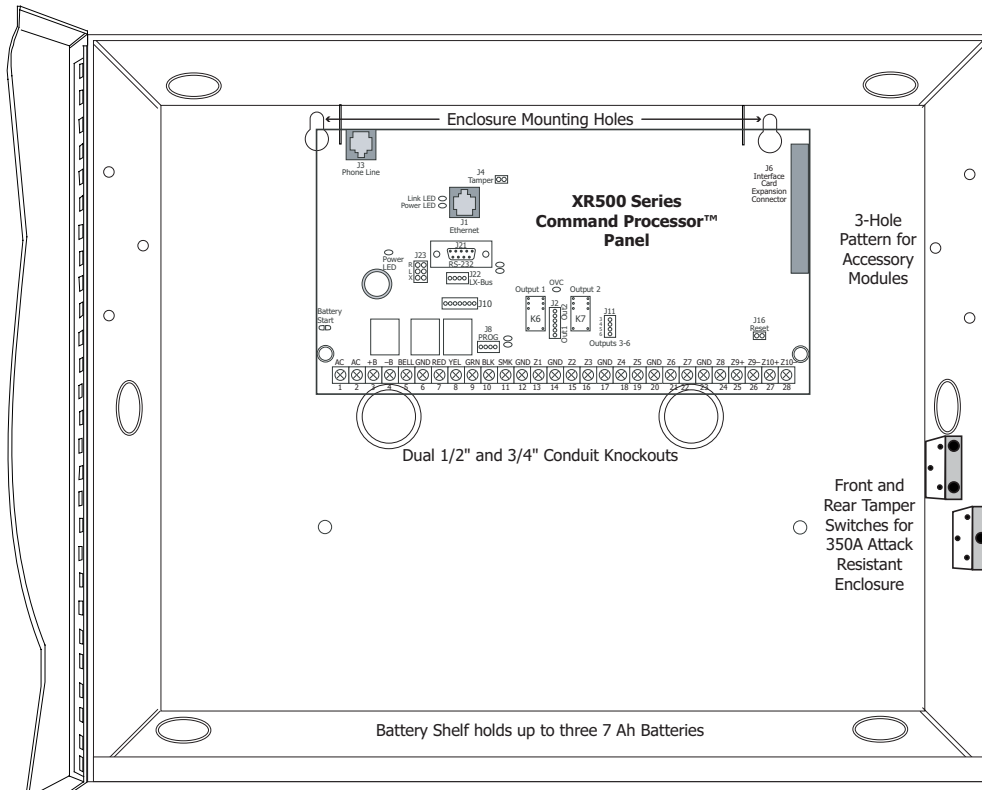

Figure 3: XR500 Series in Model 350 or 350A Enclosure

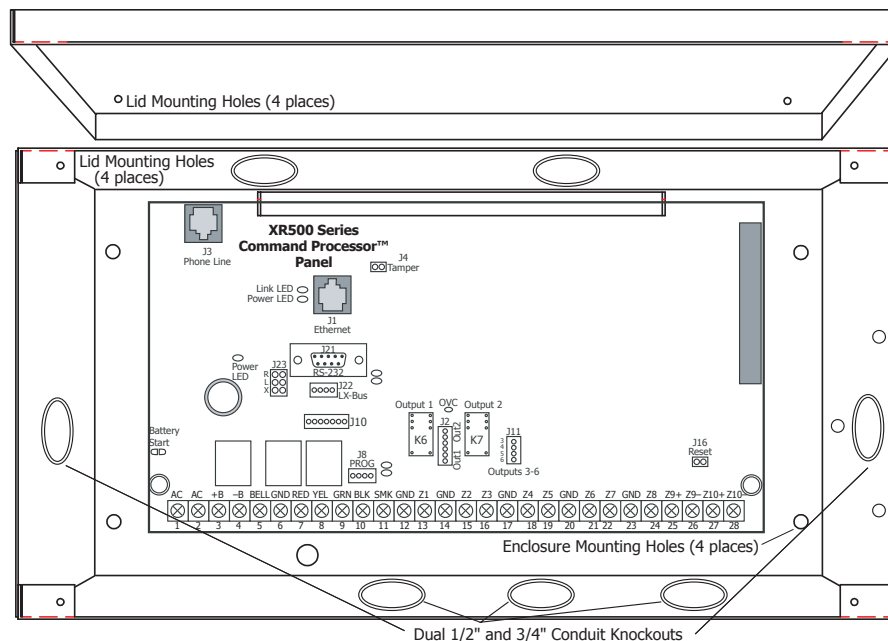

Figure 4: XR500 Series in Model 341 Enclosure

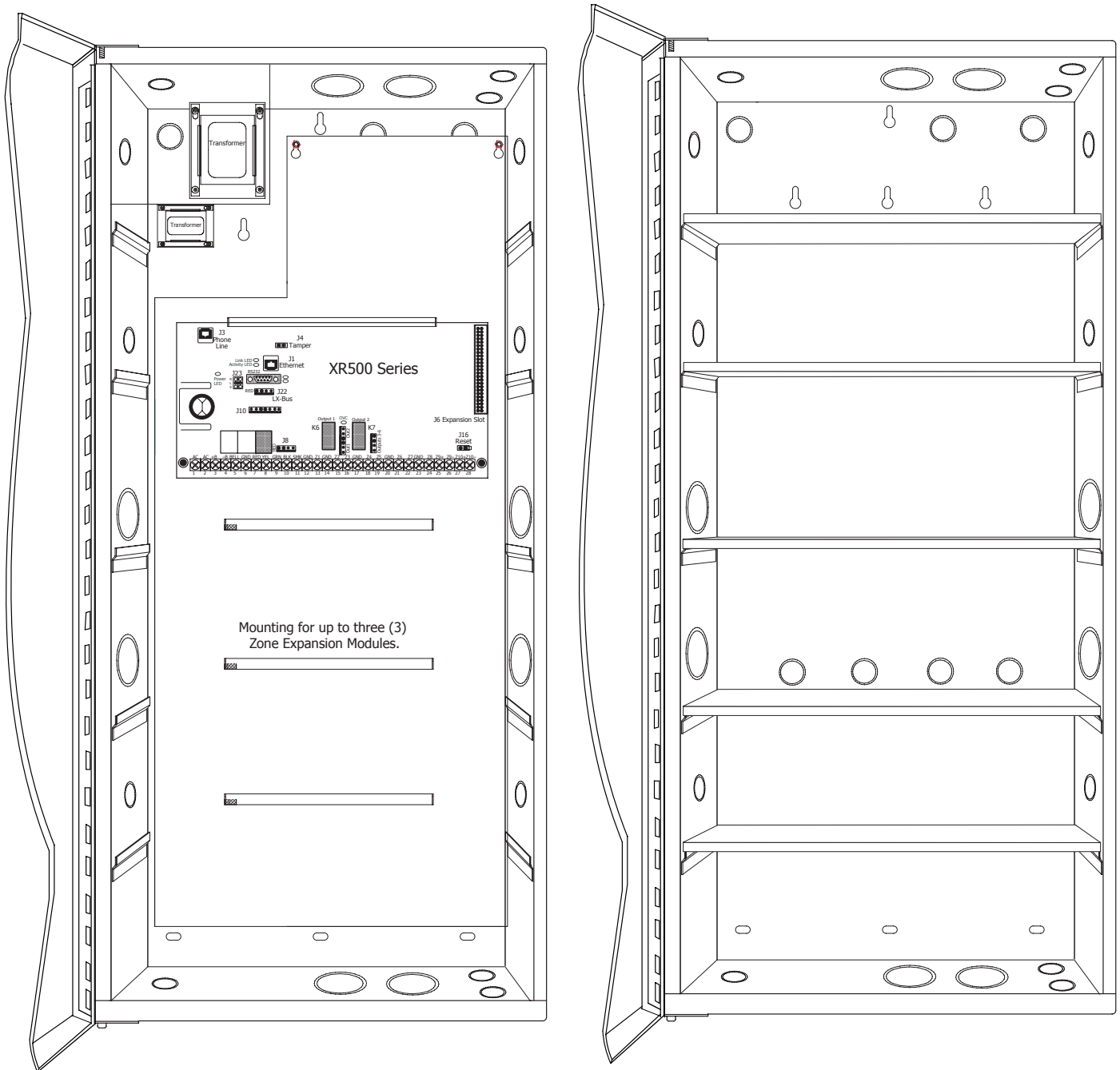

Figure 5: XR500 Series in Model 352P/352S Enclosure

4.2 Mounting Keypads and Zone Expansion Modules

DMP LCD keypads have removable covers that allow you to easily mount the keypad to a wall or other flat surface using the screw holes on each corner of the base. Before mounting the base, connect the keypad wire harness leads to the keypad cable from the panel and to any device wiring run to that location. Then attach the harness to the pin connector on the PC board, mount the base, and install the keypad cover making sure all of the keys extend through their respective holes.

For mounting keypads on solid walls, or for applications where conduit is required, use the Model 695 1-1/2" deep or the Model 696 1/2" deep backboxes.

The DMP 711, 711E, 712-8, 714, 715, 716, and 717 modules are each contained in molded plastic housings with removable covers. The base provides you with mounting holes for installing the unit to a wall, switch plate, or other surface.

4.3 Connecting LX-Bus and Keypad Bus Devices

Several factors determine the DMP LX-Bus™ and keypad bus performance characteristics: the wire length and gauge used, the number of devices connected, and the voltage at each device. When planning an LX-Bus™ and keypad bus installation, keep in mind the following information:

1. DMP recommends using 18 or 22-gauge unshielded wire for all keypad and LX-Bus circuits. **Do not use** twisted pair or shielded wire for LX-Bus and keypad bus data circuits.
2. On keypad bus circuits, to maintain auxiliary power integrity when using 22-gauge wire do not exceed 500 feet. When using 18-gauge wire do not exceed 1,000 feet. To increase the wire length or to add devices, install an additional power supply that is UL listed for Fire Protective Signaling, power limited, and regulated (12 VDC nominal) with battery backup.

Note: Each panel allows a specific number of supervised keypads. Add additional keypads in the unsupervised mode. Refer to the panel installation guide for the specific number of supervised keypads allowed.

3. Maximum distance for any one bus circuit (length of wire) is 2,500 feet regardless of the wire gauge. This distance can be in the form of one long wire run or multiple branches with all wiring totaling no more than 2,500 feet. As wire distance from the panel increases, DC voltage on the wire decreases. Maximum number of LX-Bus devices per 2,500 feet circuit is 40 feet. When using the on-board J22 LX-Bus, the maximum number of LX-Bus devices per 2,500 foot circuit is 25. See J22 LX-Bus Expansion Connector section later in this document.

For additional information refer to the 710/710F Installation Sheet (LT-0310) and or the LX-Bus/Keypad Bus Wiring Application Note (LT-2031).

Expansion Interface Cards (Models 481, 462N, 462P, 462FM, and 472)

The LX-Bus provided on these cards requires only a 4-wire cable between the card and any devices connected to the bus. You can connect devices (zone or output expansion modules) together on the same cable or provide separate runs back to the card. Each LX-Bus provides up to 100 zones or outputs.

Note: Do not use twisted pair or shielded wire when connecting an LX-Bus or keypad bus.

Primary Power Supply

5.1 AC Terminals 1 and 2

Connect the transformer wires to terminals 1 and 2 on the panel. Use no more than 70 ft. of 16 gauge or 40 ft. of 18 gauge wire between the transformer and the XR500 Series.



Always ground the panel before applying power to any devices: The XR500 Series must be properly grounded before connecting any devices or applying power to the panel. Proper grounding protects against Electrostatic Discharge (ESD) that can damage system components. See Earth ground section 6.2.

5.2 Transformer Types

Use Model 327 (16.5 VAC 50 VA) plug-in or Model 322 (16 VAC 56 VA) wire-in transformer. Use Model 322 (16 VAC 56 VA) wire-in transformer when required by the Authority Having Jurisdiction (AHJ).



The transformer must be connected to an unswitched 120 VAC 60 Hz electrical outlet with at least 350mA of available current. **Never share the transformer output with any other equipment.**

Secondary Power Supply

6.1 Battery Terminals 3 and 4

Connect the black battery lead to the negative battery terminal. The negative terminal connects to the enclosure ground internally through the XR500 Series circuit board. Connect the red battery lead to the positive terminal of the battery. Observe polarity when connecting the battery.

You can add a second battery in parallel using the DMP Model 318 Dual Battery Harness.

For UL installations, all batteries shall be installed in a DMP Model 350 enclosure and all wiring shall run through conduit. The enclosure shall be installed to the left of the XR500 Series enclosure to ensure Battery and AC wire separation.



Use sealed lead-acid batteries only: Use the DMP Model 365 (12 VDC 9 Ah), DMP Model 367 (12 VDC 7.7 Ah), Model 366 (12 VDC 18 Ah), Model 368 (12 VDC 4.5 Ah), or Model 369 (12 VDC 7 Ah) sealed lead-acid rechargeable battery. Batteries supplied by DMP have been tested to ensure proper charging with DMP products.

GEL CELL BATTERIES CANNOT BE USED WITH THE XR500 Series PANEL.

6.2 Earth Ground

To provide proper transient suppression, XR500 Series panel terminal 4 must be connected to earth ground using 14 gauge or larger wire. DMP recommends connecting to a cold water pipe, ground rod, or building ground only. Do not connect to an electrical ground or conduit, sprinkler or gas pipes, or to a telephone company ground.

6.3 Battery Only Restart

When powering up the XR500 Series panel without AC power, briefly short across the battery start pads to pull in the battery cutoff relay. The leads need a momentary short only. Once the relay has pulled in, the battery voltage holds it in that condition. If the XR500 Series panel is powered up with an AC transformer, the battery cutoff relay is pulled in automatically. For more information refer to Figure 2.

6.4 Battery Replacement Period

DMP recommends replacing the battery every 3 to 5 years under normal use.

6.5 Discharge/Recharge

The XR500 Series battery charging circuit float charges at 13.9 VDC at a maximum current of 1.0 Amps using a 50 VA or 56 VA transformer. Listed below are the various battery voltage level conditions:

Battery Trouble:	Below	11.9 VDC
Battery Cutoff:	Below	10.2 VDC
Battery Restored:	Above	12.6 VDC

6.6 Battery Supervision

The XR500 Series tests the battery when AC power is present. The test is done every three minutes and lasts for five seconds. During the test, the panel places a load on the battery; if the battery voltage falls below 11.9 VDC a low battery is detected. If AC power is not present, a low battery is detected any time the battery voltage falls below 11.9 VDC.

If a low battery is detected with AC power present, the test repeats every two minutes until the battery charges above 12.6 VDC indicating the battery has restored voltage. If a weak battery is replaced with a fully charged battery, the restored battery will not be detected until the next two minute test is completed.

6.7 Battery Cutoff

The panel disconnects the battery any time the battery voltage drops below 10.2 VDC. This prevents battery deep discharge damage.

INSTALLATION

Standby Battery Power Calculations	Standby Current	Alarm Current
736P POPIT Interface Module Radionics Popex, POPITs, OctoPOPITs	Qty _____ x 25mA _____ Qty _____ x _____mA _____	Qty _____ x 25mA _____ Qty _____ x _____mA _____
738A Ademco Wireless Interface Module	Qty _____ x 75mA _____	Qty _____ x 75mA _____
710 Bus Splitter/Repeater Module	Qty _____ x 30mA _____	Qty _____ x 30mA _____
710F Fire Bus Splitter/Repeater Module	Qty _____ x 40mA _____	Qty _____ x 40mA _____
711, 711E, 714 Zone Expansion Modules Active Zones (EOL Installed)	Qty _____ x 7mA _____ Qty _____ x 1.6mA _____	Qty _____ x 7mA _____ Qty _____ x *2mA _____
712-8 Zone Expansion Module Active Zones (EOL Installed)	Qty _____ x 19mA _____ Qty _____ x 1.6mA _____	Qty _____ x 19mA _____ Qty _____ x *2mA _____
714-8, 714-16 Zone Expansion Module Active Zones (EOL Installed)	Qty _____ x 20mA _____ Qty _____ x 1.6mA _____	Qty _____ x 20mA _____ Qty _____ x *2mA _____
715 Zone Expansion Module Active Zones (EOL Installed) 2-Wire Smokes	Qty _____ x 7mA _____ Qty _____ x 4mA _____ Qty _____ x .1mA _____	Qty _____ x 7mA _____ Qty _____ x *30mA _____ Qty _____ x .1mA _____
715-8, 715-16 Zone Expansion Modules Active Zones (EOL Installed) 2-Wire Smokes	Qty _____ x 20mA _____ Qty _____ x 4mA _____ Qty _____ x .1mA _____	Qty _____ x 20mA _____ Qty _____ x *30mA _____ Qty _____ x .1mA _____
716 Output Expansion Module Active Form C Relays	Qty _____ x 7mA _____	Qty _____ x 7mA _____ Qty _____ x 28mA _____
717 Graphic Annunciator Module Annunciator Outputs	Qty _____ x 10mA _____	Qty _____ x 10mA _____ Qty _____ x 1mA _____
521LX, 521LXT, SLRLX Smoke Detectors	Qty _____ x 8.8mA _____	Qty _____ x *28mA _____
iCOM, iCOM-E Network Alarm Routers	Qty _____ x 78.1mA _____	Qty _____ x 78.1mA _____
Aux. Powered Devices on Terminals 7 and 11 Other than Keypads and LX-Bus Modules	_____ mA	_____ mA
This page only	Sub-Total Standby _____ mA	Sub-Total Alarm _____ mA
Sub-Totals from previous page	Sub-Total Standby _____ mA	Sub-Total Alarm _____ mA
*Based on 10% of active zones in alarm	Total Standby _____ mA	Total Alarm _____ mA
<p>Total Standby _____ mA x number of Standby Hours needed _____ = _____ mA-hours</p> <p>Total Alarm _____ mA + _____ mA-hours</p> <p>Total _____ mA-hours</p> <p>X .001</p> <p>= _____ Amp-hrs Required</p>		

Refer to section 6.9 for standby battery selection.

6.9 Standby Battery Selection

To choose the type and number of batteries needed for 24, 60, or 72 hours of standby power based on the Amp Hours Required calculation from section 6.8 XR500 Series Power Requirements, perform the following:

1. Select the desired standby hours required from the table below: 24, 60, or 72 hours
2. Select the desired battery size: Model 368 (12 VDC 4.5 Ah), Model 369 (12 VDC 7 Ah), Model 367 (12 VDC 7.7 Ah), Model 365 (12 VDC 9 Ah), Model 366 (12 VDC 18 Ah).
3. Select a Max. Ah Available number that is just greater than the number calculated as the Amp Hours Required.
4. Install the number of batteries shown in the corresponding No. of Batteries required column.

Example: If the Amp Hours Required calculation equals 22 Ah for 24 hours of standby time and 4.5 Ah batteries are desired, install six (6) Model 368 (12 VDC, 4.5 Ah) batteries.

Note: You can use either a Model 327 Plug-in 50 VA or Model 322 Wire-in 56 VA Transformer with any of the Number of Batteries choices listed below.

For UL installations, all batteries shall be installed in a DMP Model 350 enclosure and all wiring shall run through conduit. The enclosure shall be installed to the left of the XR500 Series enclosure to ensure Battery and AC wire separation.

24 hours of standby power

4.5 Ah Batteries		7 Ah Batteries		7.7 Ah Batteries		9 Ah Batteries		18 Ah Batteries	
Max. Ah Available	No. of Batteries	Max. Ah Available	No. of Batteries	Max. Ah Available	No. of Batteries	Max. Ah Available	No. of Batteries	Max. Ah Available	No. of Batteries
8	2	6	1	6	1	8	1	16	1
12	3	12	2	13	2	16	2	32	2
16	4	18	3	20	3	24	3	48	3
20	5	24	4	27	4	32	4		
24	6	31	5	34	5	40	5		
28	7	37	6	41	6				
32	8	43	7						
36	9								
40	10								

Note: 48 hours is the typical battery recharge time for any of the Number of Batteries shown in this section.

60 hours of standby power

7 Ah Batteries		7.7 Ah Batteries		9 Ah Batteries		18 Ah Batteries	
Max. Ah Available	No. of Batteries	Max. Ah Available	No. of Batteries	Max. Ah Available	No. of Batteries	Max. Ah Available	No. of Batteries
13	2	14	2	17	2	17	1
20	3	22	3	26	3	34	2
27	4	29	4	34	4	52	3
33	5	37	5	43	5	69	4
40	6	44	6	52	6		
47	7	52	7	61	7		
54	8	59	8	69	8		
60	9	67	9				
67	10						

Note: 48 hours is the typical battery recharge time for any of the Number of Batteries shown in this section.

72 hours of standby power

9 Ah Batteries		18 Ah Batteries	
Max. Ah Available	No. of Batteries	Max. Ah Available	No. of Batteries
16	2	16	1
25	3	33	2
33	4	50	3
42	5	67	4
50	6		
59	7		
67	8		

Note: 72 hours is the typical battery recharge time required for any of the Number of Batteries shown in this section.

Note: If the Amp Hours Required calculation is greater than any Max. Ah Available number shown on a table, then add power supply(s) to power some system devices allowing the Amp Hours Required calculation to be reduced.

Bell Output

7.1 Terminals 5 and 6

Terminal 5 supplies positive 12 VDC to power alarm bells or horns. This output can be steady, pulsed, or temporal depending upon the Bell Action specified in Output Options. Terminal 6 is the ground reference for the bell circuit. This supervised output detects 10k Ohms or less as normal. The indicating appliance can supply this resistance. If using a horn or siren, a 1k Ohm 1/2 W EOL resistor (provided) should be added across the bell circuit to provide supervision.

Keypad Bus

8.1 Description

XR500 Series panel terminals 7, 8, 9, and 10 are for the keypad bus. You can connect up to sixteen supervised keypads and multiple unsupervised keypads to the XR500 Series. In addition to DMP LCD keypads, you can also connect any combination of zone expansion modules to the data bus. Refer to the specific device Installation sheet for the maximum number of keypad Bus devices.

Refer to the section titled LX-Bus for complete information about the LX-Bus 4-pin header and expansion slot.

Note: Do not use shielded wire for LX-Bus/Keypad Bus circuits.

8.2 Terminal 7 - RED

This terminal supplies positive 12 VDC to power DMP LCD keypads and zone expansion modules. Terminal 7 also supplies power for any auxiliary device. The ground reference for terminal 7 is terminal 10.

The output current is shared with the smoke power output on terminal 11 and Zones 9 and 10. Current draw for all connected devices must not exceed the panel maximum current rating.

8.3 Terminal 8 - YELLOW

Terminal 8 receives data from keypads and zone expansion modules. It cannot be used for any other purpose.

8.4 Terminal 9 - GREEN

Terminal 9 transmits data to keypads and zone expansion modules. It cannot be used for any other purpose.

8.5 Terminal 10 - BLACK

Terminal 10 is the ground reference for DMP LCD keypads, zone expansion modules, and all auxiliary devices being powered by terminal 7.

8.6 J8 Programming Connection

A 4-pin header (J8) is provided to connect a keypad when using a DMP Model 330 Programming Cable. This provides a quick and easy connection for panel programming.

You may also use the J8 Programming Header to connect Keypad Bus devices. This is an alternative to connecting keypad bus devices to terminals 7, 8, 9, and 10.

8.7 OVC LED

The Overcurrent LED (OVC) lights Red when the devices connected to the Keypad Bus and LX-Bus(es) draw more current than the panel is rated for. The OVC is located above Outputs 1 and 2 on the panel and turns a steady Red when lit. When the OVC LED lights Red, the LX-Bus(es) and Keypad bus are shut down.

Smoke and Glassbreak Detector Output

9.1 Terminals 11 and 12

Terminal 11 supplies positive 12 VDC to power 4-wire smoke detectors and other powered devices. This output can be turned off by the user for 5 seconds using the Sensor Reset User Menu option to allow latched devices to reset. Terminal 12 is the ground reference for terminal 11. See LT-0164 for a list of approved 4-wire smoke detectors and power supervision relays.

9.2 Current Rating

The Output current from terminal 11 is shared with terminals 7, 25, and 27.



The total current draw of all devices powered from the panel must be included with terminal 11 calculations and must not exceed the maximum output rating.

Protection Zones

10.1 Terminals 13–24

Zones 1 to 8 (terminals 13 to 24) on the XR500 Series panel are all grounded burglary zones. For programming purposes, the zone numbers are 1 through 8. Listed below are terminal 13 to 24 connection functions.

Terminal	Function	Terminal	Function
13	Zone 1 voltage sensing	19	Zone 5 voltage sensing
14	Ground for Zones 1 and 2	20	Ground for Zones 5 and 6
15	Zone 2 voltage sensing	21	Zone 6 voltage sensing
16	Zone 3 voltage sensing	22	Zone 7 voltage sensing
17	Ground for Zones 3 and 4	23	Ground for Zones 7 and 8
18	Zone 4 voltage sensing	24	Zone 8 voltage sensing

The voltage sensing terminal measures the voltage across a 1k Ohm End-of-Line resistor to ground. Use DMP Model 311 1k Ohm resistors. Dry contact sensing devices can be used in series (normally-closed) or in parallel (normally-open) with any of the burglary protection zones.

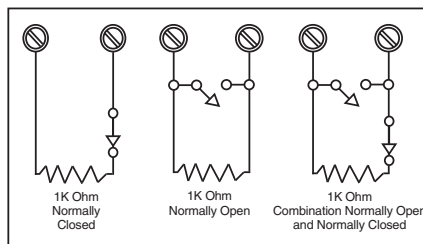

Figure 6: Protection Zone Wiring

10.2 Operational Parameters

Each protection zone detects three conditions: Open, Normal, and Short. Listed below are voltage and resistance parameters for each condition:

Condition	Resistance on zone	Voltage on positive terminal
Open	over 1300 ohms	over 2.0 VDC
Normal	600 to 1300 ohms	1.2 to 2.0 VDC
Short	under 600 ohms	under 1.2 VDC

10.3 Zone Response Time

A condition must be present on a zone for 500 milliseconds before it is detected by the XR500 Series panel. Ensure detection devices used on the protection zones are rated for use with this delay. Zones 1-10 can also be programmed for a fast response delay of 160 milliseconds.

10.4 Keyswitch Arming Zone

Using a keyswitch on an Arming type zone allows you to arm and disarm selected areas without having to enter a user code.

Powered Zones for 2-Wire Smoke Detectors

11.1 Terminals 25–26 and 27–28

Panel terminals 25 through 28 provide two resettable Class B, Style A, 2-wire powered zones. For programming purposes the zone numbers are 9 and 10.

Note: The maximum wire length for either zone 9 or zone 10 is 3000 feet using 18 AWG or 1000 feet using 22 AWG.

When using 725 Zone Expansion Modules, use UL Listed Model 316 EOL resistors. The UL compatibility identifier for the zones using 725 Zone Expansion Modules is B. When using all other zone expansion modules, use UL Listed Model 309 EOL resistors. The UL compatibility identifier for the zones is A.

Note: Do not mix detectors from different manufacturers on the same zone.



Caution: Performing a Sensor Reset momentarily drops power to the devices on Zones 9 and 10. The panel views these zones (9 and 10) as “Open” while the power is absent.

INSTALLATION

11.2 Compatible 2-Wire Smoke Detector Chart

Manufacturer	Model	Detector ID	Base	Base ID	DC Voltage Range	# of Detectors (12V/24V)	Zone Expansion Modules	Panel Zones
Detection Systems	DS230, DS230F	B/A	MB2W, MB2WL	A	8.5-33	10	725	
Detection Systems	DS250, DS250TH	B	MB2W, MB2WL	A	8.5-33	10/12	715, 715-8, 715-16, 725	9 & 10
Detection Systems	DS250HD	B	MB2W, MB2WL	A	8.5-33	10	715, 715-8, 715-16	9 & 10
Detection Systems	DS260	B/A	MB2W, MB2WL	A	8.5-33	17	725	
Detection Systems	DS282, DS282TH, DS282THC, DS282THS	B			8.5-33	10/12	715, 715-8, 715-16, 725	9 & 10
DMP/Hochiki	SLR-835	HD-3	NS6-100	HB-55	8-35	7/14	725	
DMP/Hochiki	SLR-835B	HD-6	N/A		8-35	7/14	725	
Hochiki	SLR-835B-2 SLR-835BH-2	HD-6	N/A		8-35	14	725	
Hochiki	SLR-24, SLR-24H	HD-3	NS4-220	HB-3	15-33	15	725	
Hochiki	SIJ-24, DCD-190, DCD-135	HD-3	NS4-220	HB-3	15-33	15	725	
Hochiki	SLR-24, SLR-24H	HD-3	NS6-220	HB-3	15-33	15	725	
Hochiki	SIJ-24	HD-3	NS6-220	HB-3	15-33	20	725	
Hochiki	DCD-190, DCD-135	HD-3	NS6-220	HB-3	15-33	16	725	
Sentrol/ESL	429AT, 521B, 521BXT, 521NB, 521NBXT	S09A			6.5-20	12	715, 715-8, 715-16	9 & 10
Sentrol/ESL	429C, 429CT, 521B/BXT	S10A			8.5-33	12	725	
Sentrol/ESL	429CRT, 429CST, 429CSST, 521CRXT	S11A			8.5-33	12	725	
Sentrol/ESL	711U, 712U, 713-5U, 713-6U, 721U, 721UT	S10A	701E, 70-1U, 702E, 702U	S00	8.5-33	12	725	
Sentrol/ESL	731U, 723U	S11A	701E, 701U, 702E, 702U, 702RE, 702RU	S00	8.5-33	12	725	
System Sensor	1400	A			8.5-35	10	715, 715-8, 715-16	9 & 10
System Sensor	1151, 2151	A	B110PL, B401		8.5-35	10/10	715, 715-8, 715-16, 725	9 & 10
System Sensor	1451, 2451TH	A	B401, B401B		8.5-35	10	715, 715-8, 715-16	9 & 10
System Sensor	1451DH	A	DH400		8.5-35	10	715, 715-8, 715-16	9 & 10
System Sensor	2100T, 2100B, 2100TB, 2100D, 2100TD	A			8.5-35	10	715, 715-8, 715-16	9 & 10
System Sensor	2400, 2400AT, 2400AIT, 2400TH	A			8.5-35	10	715, 715-8, 715-16	9 & 10
System Sensor	2451	A	B401, B401B, DH400		8.5-35	10	715, 715-8, 715-16	9 & 10
System Sensor	2W-B, 2WT-B	A			8.5-35	10	715, 715-8, 715-16	9 & 10
System Sensor	DH100P, DH100LP	A			8.5-35	10	715, 715-8, 715-16, 725	9 & 10

Figure 7: Compatible 2-Wire Smoke Detectors

Dry Contact Relay Outputs

12.1 Description

The XR500 Series panel provides two auxiliary SPDT relays when equipped with two DMP Model 305 relays in sockets K6 (Output 1) and K7 (Output 2) and a Model 431 Output Harness on the J2 6-pin Header. Each relay provides one SPDT set of contacts that can be operated by any of the functions listed below:

- | | |
|---|-----------------------------|
| 1) Activation by zone condition: Steady, Pulsing, Momentary, and Follow | |
| 2) Activation by 24-hour 7-day schedule: One on and one off time a day for each relay | |
| 3) Manual activation from the DMP LCD keypad menu | |
| 4) Communication failure | |
| 5) Armed area annunciation | 9) System Ready |
| 6) Fire Alarm or Fire Trouble | 10) Ground start activation |
| 7) Ambush Alarm | 11) Cellular Backup |
| 8) Exit and Entry timers | 12) Late to Close |

Refer to the XR500 Series Programming Guide (LT-0679) for specific information.

12.2 Contact Rating

The Model 305 relay contacts are rated for 1 Amp at 30 VDC resistive. You can connect auxiliary power to the Relay Output 1 common terminal by installing the gray harness wire to terminal 7. Current draw for all connected devices must not exceed the panel maximum current rating.

12.3 Model 431 Output Harness Wiring

The relay contacts are accessible by installing the DMP 431 Output Harness on the 6-pin header labeled J2. Output 2 uses the top three prongs, and output 1 uses the bottom three prongs. The wire harness and contact locations are shown below:

Contact	Color
Output 1 normally closed	Violet
Output 1 common	Gray
Output 1 normally open	Orange
Output 2 normally closed	Violet with white stripe
Output 2 common	White with gray stripe
Output 2 normally open	Orange with white stripe

The relay contacts must be connected to devices located within the same room as the XR500 Series panel.

Annunciator Outputs

13.1 Description

The four annunciator outputs can be programmed to indicate the activity of the panel zones or conditions occurring on the system. Annunciator outputs do not provide a voltage but instead switch-to-ground a voltage from another source. The outputs can respond to any of the conditions listed in section 12.1 above.

13.2 Model 300 Harness Wiring

Access the open collector outputs by installing DMP 300 Harness on the 4-pin header labeled J11. The output locations are shown below. For UL applications, devices connected to the outputs must be located within the same room as the panel.

Output	Color	Wire	Output	Color	Wire
3	Red	1	5	Green	3
4	Yellow	2	6	Black	4

13.3 Model 860 Relay Module

Connect a Model 860 Relay Module to the J11 on the XR500 Series panel to provide relays for outputs 3-6. Use these relays for electrical isolation between the alarm panel and other systems or for switching voltage to control various functions. Power is supplied to the relay coils from a single wire connected to the panel auxiliary power terminal 7. The module includes one relay and provides three additional sockets for expansion of up to four relays. Mount the 860 inside the panel enclosure using the 3-hole pattern and plastic standoffs. Refer to the 860 Module Install Sheet (LT-0484) as needed.

Relay Contact Rating: 1 Amp at 30 VDC

J23 6-Pin Header

14.1 Description

The XR500 Series Command Processor™ panel supports RS-232, LX-Bus and future expansion operation. These operations cannot function at the same time. Install a jumper on one pair of J23 headers to indicate how the panel is programmed to operate. Refer to the table below when installing a jumper on J23.

J23 6-Pin Header	
Letter	Operation
R	Standard RS-232
L	LX-Bus
X	Future Expansion

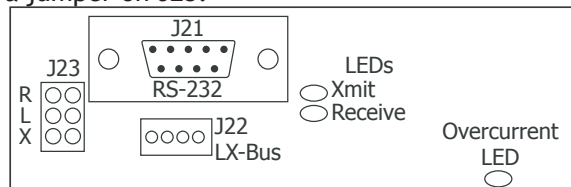

Figure 8: J23 6-Pin Header

J22 LX-Bus Expansion Connector

15.1 Description

The XR500 Series Command Processor™ Panel supports up to five LX-Bus circuits. Each Interface card LX-Bus circuit provides 100 expansion zones. The maximum number of LX-Bus zones available on a fully populated panel is 500. Use J22 LX-Bus Header for 100 zones. Install a single Interface Card Connector on the board to support 100 additional zones for a total of 200 zones. To install up to five Interface Cards install a Model 461 Interface Adaptor Card.

15.2 J22 LX-Bus Header

Note: J22 LX-Bus and J21 RS-232 connectors cannot be used at the same time. Either use J21 to connect a serial device for PC Log Reporting, or use J22 to connect an LX-Bus device. This is determined by where you install the jumper on J23 6-Pin Header.

To enable J22 to operate as an LX-Bus, place a jumper on the two pins next to the letter “L” on the J23 6-Pin header. When using J22 as an LX-Bus, connect a DMP Model 300 4-wire Harness to the J22 4-pin header labeled LX-BUS. This provides the first 100 LX-Bus zones numbered 500-599. No LX-Bus Interface Card is required. Respect wire colors when connecting devices and use all four wires.

Note: Do NOT use shielded wire when using the LX-Bus. Do NOT connect the wires from the 4-wire harness to the panel terminals.

The maximum distance for any one bus circuit (length of wire) is 2,500 feet regardless of the wire gauge. This distance can be in the form of one long wire run or multiple branches with all wiring totaling no more than 2,500 feet. As wire distance from the panel increases, DC voltage on the wire decreases. Maximum number of LX-Bus devices per 2,500 feet circuit is 25 when using the on-board J22 LX-Bus. For additional information refer to the 710/710F Installation Sheet (LT-0310) and or the LX-Bus/Keypad Bus Wiring Application Note (LT-2031).

15.3 LX-Bus Interface Cards

You can add one Interface Card (Model 481, 462N, 462P, 462FM, and 472) to the XR500 Series using J6 Interface Card Connector located on the board right edge. To add more than one Interface Card install a 461 Interface Adaptor Card using J6 Interface Card Connector on the board right edge. The 461 Adaptor Card allows you to install up to five Interface Cards. Refer to the 461 Installation Sheet (LT-0736). Each Interface card provides up to 100 LX-Bus Zones. Refer to the following tables to identify zone locations and numbers relative to J22 operation.

J22 LX-Bus Enabled			AND	One Interface Card			OR	461 Adaptor Card and Multiple Interface Cards		
LX-Bus	Zones	Numbers		LX-Bus	Zones	Numbers		LX-Bus	Zones	Numbers
1	100	500-599		2	100	600-699		2 (A)	100	600-699
								3 (B)	100	700-799
								4 (C)	100	800-899
								5 (D)	100	900-999

J22 LX-Bus NOT Enabled	One Interface Card			OR	461 Adaptor Card and Multiple Interface Cards		
	LX-Bus	Zones	Numbers		LX-Bus	Zones	Numbers
	1	100	500-599		1 (A)	100	500-599
					2 (B)	100	600-699
					3 (C)	100	700-799
					4 (D)	100	800-899
					5 (E)	100	900-999

15.4 LX-Bus LEDs

The two LEDs, located near the bottom-right corner of J21 indicate data transmission and receipt. The top LED flashes green to indicate the panel is transmitting LX-Bus data. The bottom LED flashes yellow to indicate the panel is receiving LX-Bus data.

15.5 OVC LED

The Overcurrent LED (OVC) lights Red when the devices connected to the Keypad Bus and LX-Bus(es) draw more current than the panel is rated for. The OVC is located above Outputs 1 and 2 on the panel and turns a steady Red when lit. When the OVC LED lights Red, the LX-Bus(es) and Keypad bus shut down.

J21 Serial Connector

16.1 Description

Note: J22 LX-Bus and J21 RS-232 connectors cannot be used at the same time. Either use J21 to connect a serial device, or use J22 to connect an LX-Bus device. This is determined by where you install the jumper on the J23 6-Pin Header.

To enable J21 to operate in RS-232 mode place a jumper on the two pins next to the letter "R" on the J23 6-Pin header. The Serial Connector allows the following operation options.

XR500 Panel	XR500N/XR500E Panel
PC Log Reports	PC Log Reports
Remote Link™ Programming	iCOM Installation for PC Log Reports

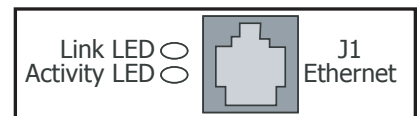

Figure 9: J1 Header and LEDs

16.2 Serial Connector LEDs

The two LEDs, located near the bottom-right corner of J21 indicate data transmission and receipt. The top LED flashes green to indicate the panel is transmitting serial data. The bottom LED flashes yellow to indicate the panel is receiving serial data.

J1 Ethernet Connector (XR500N/XR500E only)

17.1 Description

The J1 Ethernet Connector is available on the XR500N/XR500E Network version to connect directly to an Ethernet network using a standard patch cable.

17.2 Ethernet LEDs

The two LEDs, located to the left of J1 Ethernet Connector, indicate network operation. The top, Link LED flashes green to indicate the network traffic is good. The bottom, Activity LED flashes yellow to indicate messages are being sent and received.

J3 Telephone RJ Connector

18.1 FCC Registration

The Model XR500 Series complies with Part 68 of the FCC rules and the requirements adopted by the ACTA. On the outside of the enclosure of this equipment is a label that contains, among other information, a product identifier in the format US:CCKAL00BXR500. If requested this number must be provided to the telephone company.

A plug and jack used to connect this equipment to the premises wiring and telephone network must comply with the applicable FCC Part 68 rules and requirements adopted by the ACTA. See installation instructions for details.

The Ringer Equivalence Number (REN) is used to determine the number of devices that may be connected to a telephone line. Excessive RENs on a telephone line may result in the devices not ringing in response to an incoming call. In most but not all areas, the sum of RENs should not exceed five (5.0). To be certain of the number of devices that may be connected to a line, as determined by the total RENs, contact the local telephone company.

If the XR500 Series causes harm to the telephone network, the telephone company will notify you in advance that temporary discontinuance of service may be required. But if advance notice isn't practical, the telephone company will notify the customer as soon as possible. Also, you will be advised of your right to file a complaint with the FCC if you believe it is necessary.

The telephone company may make changes in its facilities, equipment, operations or procedures that could affect the operation of the equipment. If this happens the telephone company will provide advance notice in order for you to make necessary modifications to maintain uninterrupted service.

INSTALLATION

If trouble is experienced with the Model XR500 Series, for repair or warranty information, please contact DMP at the address and telephone number listed on the back of this document. If the equipment is causing harm to the telephone network, the telephone company may request that you disconnect the equipment until the problem is resolved.

If your premises has specially wired alarm equipment connected to the telephone line, ensure the installation of the XR500 Series does not disable your alarm equipment. If you have questions about what will disable alarm equipment, consult your telephone company or a qualified installer.

Caution: To ensure proper operation, this equipment must be installed according to the installation instructions in this manual. To verify that the equipment is operating properly and can successfully report an alarm, this equipment must be tested immediately after installation, and periodically thereafter, according to the test instructions in this document and the XR500 Series Programming Guide (LT-0679). Additionally, verification of Line Seize capability should be made immediately after installation, and periodically thereafter, in order to ensure that this equipment can initiate a call even when other equipment (telephone, answering system, computer modem, etc.) connected to the same line is in use.

18.2 Description

Connect the panel to the public telephone network by installing a DMP 356 RJ Cable between the panel J3 connector and the RJ31X or RJ38X phone jack.

18.3 J10 893A Connector

Connect an 893A Dual Phone Line Module to J10 on the XR500 Series. Refer to the 893A Installation Sheet (LT-0135) for complete information.

18.4 Notification

The user must not repair registered terminal equipment. In case of trouble, immediately unplug the device from the telephone jack. The factory warranty provides for repairs. Registered terminal equipment may not be used on party lines or in connection with coin telephones. Notify the telephone company with the following information:

- a. The particular line(s) where the service is connected
- b. The FCC registration number as listed in Section 18.1
- c. The ringer equivalence
- d. The device make, model, and serial number

18.5 Phone Line Monitor

The XR500 Series panel has a built-in telephone monitor that monitors the phone line voltage to verify the connection to the central office. Figure 10 and the table below identify the phone block pin layout, wire numbers, and colors.

Wire Number	Wire Color
1	Gray
2	Orange
3	Black
4	Red
5	Green
6	Yellow
7	Blue
8	Brown

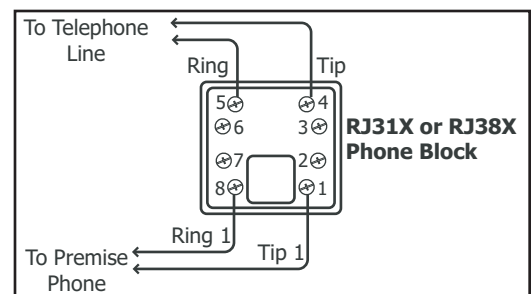

Figure 10: Phone Jack Wiring

The wires on the RJ31 that feed pins 4 and 5 should be the ONLY wires on the D-marc. All other house phone wiring should be tied to pins 1 and 8 coming back from the RJ31.

Dial tone must come into RJ31X on pins 4 and 5 and go back to house phones from pins 1 and 8. Follow these steps to determine if panel is seizing the line:

1. Unplug phone cord from RJ31X
2. Place butt-set on pins 4 and 5
3. Listen for dial tone. With dial tone present, lift either wire from pins 1 or 8
4. Listen for dial tone again. If the dial tone is present, RJ31X wiring is correct. If no dial tone is present, the RJ31X wiring is backwards. Rewire so dial tone is coming in on 4 and 5.

If you still have trouble with the phone line, you may need to replace the RJ cord. If the dial tone is still not present, swap out the RJ31X phone block.

Reset and Tamper Headers

19.1 J16 Reset Header

The reset header is located just above the terminal strip on the right side of the circuit board and is used to reset the XR500 Series microprocessor. To reset the panel when first installing the system, install the reset jumper before applying power to the panel. After connecting the AC and battery, remove the reset jumper.

To reset the panel while the system is operational, for example, prior to reprogramming, install the reset jumper without powering down the system. Remove the reset jumper after one or two seconds.

After resetting the panel, begin programming within 30 minutes. If you wait longer than 30 minutes, you must reset the panel again.

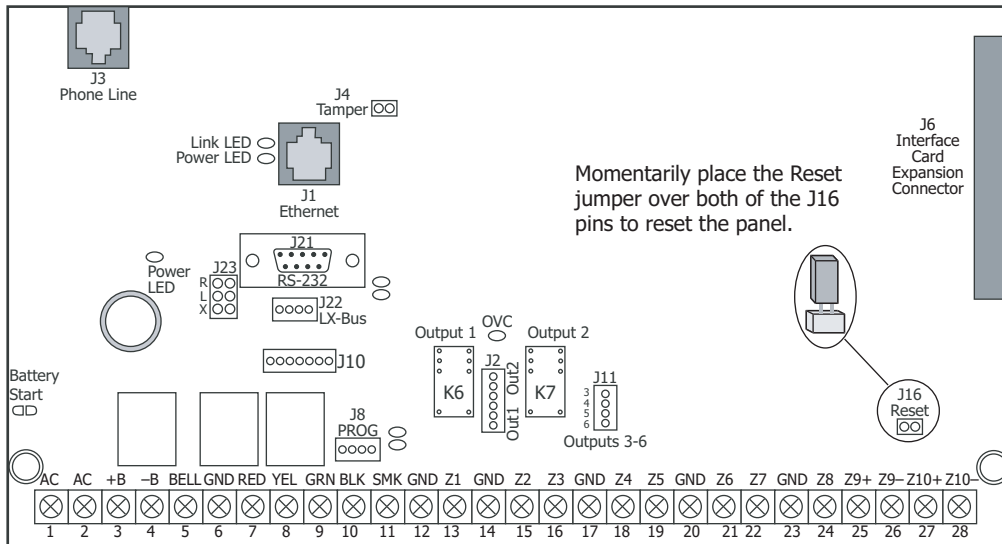

Figure 11: XR500 Series Panel Showing the Reset Jumper

19.2 J4 Tamper Header

The J4 header is for use with the optional DMP 306 Tamper Harness. The harness connects to one or more tamper switches mounted inside the panel enclosure to supervise against unauthorized enclosure opening or removal. Refer to the wiring diagram on the enclosure door for correct tamper switch wiring.

How the Tamper Works

If the enclosure is opened or removed while one or more of the system areas are armed, a panel tamper alarm is indicated. If all areas are disarmed, a panel tamper trouble is indicated.

Universal UL Burglary Specifications

20.1 Introduction

The programming and installation specifications contained in this section must be completed when installing the XR500 Series panel in accordance with any of the UL burglary standards. Additional specifications may be required by a particular standard.

20.2 Wiring

All wiring must be in accordance with NEC, ANSI/NFPA 70, UL 681, and UL 827 for all burglary installations. All transformer wires must be installed in conduit.

20.3 Control Outside of Protected Area

A Potter EVD or Sentrol 5402 should be used in place of a lined cabinet when the panel is installed outside of the protected area. Front and rear tamper switches are required. Refer to the system wiring diagram and Figure 2.

20.4 Police Station Phone Numbers

The digital dialer telephone number programmed for communication must not be a police station phone number.

20.5 Bypass Reports

The Bypass Reports option must be programmed as YES for all UL burglary applications. See the XR500 Series Programming Guide (LT-0679).

20.6 System Maintenance

To ensure continuous satisfactory operation of any alarm system, proper installation and regular maintenance by the installing alarm company and frequent testing by the end user is essential. Offering a maintenance program and acquainting the user with the correct procedures for system use and testing is also the responsibility of the installing alarm company.

20.7 UL Listed Receivers

UL has verified operation with the DMP SCS-1 and SCS-1R, Sur-Gard SG-HLR2-DG, FBII CP220PB, Osborne-Hoffman Quick-Alert, and Radionics D6500 receivers. It is the installer's responsibility to verify compatibility between the XR500 Series and the receiver used during installation. The installer shall verify the compatibility of the receiver and the system on a yearly basis.

20.8 Power Supply Supervision

For commercial burglary applications the power supply for all local bells shall be under 24-hour protection. Refer to section 6 in this document.

Area Information

21.1 Ownership

The control unit system shall be under one ownership.

21.2 Annunciation

The System shall be installed so that when arming any area from any keypad, the local bell shall annunciate.

21.3 Trouble Display

The Status List programming shall be set to annunciate all trouble messages at all keypads. See the XR500 Series Programming Guide (LT-0679).

21.4 Closing Wait

The Closing Wait option must be programmed YES. See the XR500 Series Programming Guide (LT-0679).

21.5 Local Bell Supervision

When a local bell is employed, the power supply for the bell shall be under 24-hour protection. Proper personnel for maintenance or security of the system shall be able to disarm that area.

UL 1023 Specifications

Household Burglar-Alarm System Units

22.1 Audible Devices

At least one listed audible device (Ademco AB12M) rated to operate over the voltage rate of 11.7 VDC to 12.8 VDC and rated at 85 DB minimum must be used.

22.2 Auxiliary Circuits

At least one burglary alarm initiating device shall be used on the system. If the voltage for the device is applied by the control unit the burglary alarm initiating device shall be rated to operate over the range of 11.5 VDC to 12.7 VDC.

22.3 Bell Cutoff

The Bell Cutoff time cannot be less than five minutes. See the XR500 Series Programming Guide (LT-0679).

22.4 Entry Delay

The maximum entry delay used must not be more than 45 seconds. See the XR500 Series Programming Guide (LT-0679).

22.5 Exit Delay

The maximum exit delay used must not be more than 60 seconds. See the XR500 Series Programming Guide (LT-0679).

22.6 Weekly Test

The product should be tested weekly.

UL 1610 AND 1076 Specifications

Central-Station and Proprietary Burglar-Alarm Units

23.1 Opening/Closing Reports

The Opening/Closing Reports option must be programmed as YES. See the XR500 Series Programming Guide (LT-0679).

23.2 Closing Wait

The Closing Wait option must be programmed YES. See the XR500 Series Programming Guide (LT-0679).

23.3 Entry Delay

The maximum entry delay used must not be more than 60 seconds when using the Model 350A Grade A Attack Resistant Housing. See the XR500 Series Programming Guide (LT-0679).

23.4 Exit Delay

The maximum exit delay used must not be more than 60 seconds. See the XR500 Series Programming Guide (LT-0679).

23.5 Proprietary Dialer

The Model XR500 Series provides Grade A proprietary service when configured as a digital dialer.

23.6 Grade B Central Station

Grade B Central Station service can be provided under by adding a Grade A Ademco AB12M bell and bell housing and placing the Model XR500 Series panel into the Model 350A Grade A Attack Resistant Housing.

23.7 Bell Cutoff

The Bell Cutoff time cannot be less than 15 minutes. See the XR500 Series Programming Guide (LT-0679).

23.8 AA High Line Network Security

High Line Security is provided when configured as a NET system using an XR500N panel or an XR500 panel with an iCOM™ Network Alarm Router. The NET Check-in time must be set from 01 to 06 minutes or AA. When a dialer is required for 06 minute check-in time, an attack resistant enclosure (DMP Model 350A) is required. When the check-in time is set to a number less than 200 seconds, an attack resistant enclosure is not required. See sections 3.2, 3.2.1, and 3.3 of the XR500 Series Programming Guide (LT-0679).

To provide High Line Encrypted security, install an XR500E panel or an XR500 panel with an iCOM-E™ Encrypted Network Alarm Router.

For high line security operation, communication between the Premise and Supervising Station provides 128 bit encryption when using an XR500E panel or an XR500 panel with an iCOM-E Encrypted Network Alarm Router.

The Model XR500 Series Protected Premises Control Unit is suitable for Grade AA service when configured for NET communication with SCS-1/SCS-1R receiving system. This configuration is approved for the following:

- AMCX - Central Station Alarm Units
- APOU - Proprietary Alarm Units

UL 1635 Specifications

Digital Burglar Alarm Communicator System Units

24.1 System Trouble Display

The Status List Display must include at least one keypad that displays system monitor troubles. See the XR500 Series Programming Guide (LT-0679).

24.2 Digital Dialer Telephone Number

Both programmed telephone numbers must begin with a P. See the XR500 Series Programming Guide (LT-0679).

24.3 Test Time

The Test Time option must be programmed so that the XR500 Series sends a report once every 24 hours. See the XR500 Series Programming Guide (LT-0679).

24.4 Closing Wait

The Closing Wait option must be programmed YES. See the XR500 Series Programming Guide (LT-0679).

UL 365 Specifications

Police Station Connected and Local Burglar Alarm Units and Systems

25.1 System Trouble Display

The Status List Display must include at least one keypad that displays system monitor troubles. See the XR500 Series Programming Guide (LT-0679).

25.2 Entry Delay

The maximum entry delay used must not be more than 60 seconds when using the Model 350A Grade A housing. See the XR500 Series Programming Guide (LT-0679).

25.3 Exit Delay

The maximum exit delay used must not be more than 60 seconds. See the XR500 Series Programming Guide (LT-0679).

25.4 Grade A Bell

A Grade A local audible signal appliance must be used such as Ademco AB12M bell and bell housing.

25.5 Bell Cutoff

The Bell Cutoff time cannot be less than 15 minutes. See the XR500 Series Programming Guide (LT-0679).

25.6 Automatic Bell Test

The Automatic Bell Test option must be programmed as YES. See the XR500 Series Programming Guide (LT-0679).

25.7 Line Security for Police Connect

Basic line security is provided when the Model XR500 Series is configured as a dialer system.

25.8 AA High Line Network Security

High Line Security is provided when configured as a NET system using an XR500N panel or an XR500 panel with an iCOM™ Network Alarm Router. The NET Check-in time must be set from 01 to 06 minutes or AA. When a dialer is required for 06 minute check-in time, an attack resistant enclosure (DMP Model 350A) is required. When the check-in time is set to a number less than 200 seconds, an attack resistant enclosure is not required. See sections 3.2, 3.2.1, and 3.3 of the XR500 Series Programming Guide (LT-0679).

To provide High Line Encrypted security, install an XR500E panel or an XR500 panel with an iCOM-E™ Encrypted Network Alarm Router.

For high line security operation, communication between the Premise and Supervising Station provides 128 bit encryption when using an XR500E panel or an XR500 panel with an iCOM-E Encrypted Network Alarm Router.

UL 609 Specifications

Police Station Connected and Local Burglar Alarm Units and Systems

26.1 Grade A Mercantile

For Grade A Mercantile and Police Station Connect operation the Model XR500 Series must be mounted in a Grade A Attack Resistant Housing, (DMP Model 350A).

26.2 Entry Delay

The maximum entry delay used must not be more than 60 seconds when using the Model 350A Grade A housing. See the XR500 Series Programming Guide (LT-0679).

26.3 Exit Delay

The maximum exit delay used must not be more than 60 seconds. See the XR500 Series Programming Guide (LT-0679).

26.4 Mercantile Safe and Vault

When the DMP Model 350A housing is used, the XR500 Series provides operation as a mercantile safe and vault alarm. Bell Supervision and wiring must be in accordance with UL 681. When the XR500 Series is mounted outside the safe or vault, tamper protection and the Sentrol Model 5402 or Potter EVD listed vibration detectors should be used.

26.5 Grade A Bell

A Grade A local audible signal appliance must be used such as Ademco AB12M bell and bell housing.

26.6 Bank Safe and Vault (XR500N/XR500E only)

In addition to the requirements for Mercantile Safe and Vault in section 26.4, the following must be done for Bank Safe and Vault systems. The Bank Safe and Vault option must be programmed as YES. See the XR500 Series Programming Guide (LT-0679). The 72 hour battery standby must be provided. A Rothenbuhler Model 5110 High Security Bell must be used. See section 32.5 wiring diagram.

UL 294 Specifications

27.1 Panel Designation

The XR500 Series panels are designated stand alone units.

27.2 Compatible Devices

The following devices are compatible with the XR500 Series panels.

Access Control	
733 Wiegand Interface Module	Proximity reader connector
734 Wiegand Interface Module	Proximity reader connector
OP-08CB Motion Detector	Infrared sensor
* PB-2 REX Button	Exit control push button
PP-6005B Proxpoint Plus® Reader	Proximity reader
MP-5365 Miniprox® Reader	Slimline proximity reader
PR-5455 ProxPro® II Reader	Long range reader with sounder
MX-5375 Maxi-Prox™ Reader	Long range reader compatible with 1351 Prox Pass
* This device has not been investigated by UL and shall not be used in UL installations.	

27.3 Tamper Protection

For UL Listed Access Control installations, a tamper switch must be used.

Universal UL and NFPA Fire Alarm Specifications

28.1 Introduction

The programming and installation specifications contained in this section must be completed when installing the Model XR500 Series in accordance with any of the UL or NFPA fire standards. Additional specifications may be required by a particular standard.

28.2 Wiring

All wiring must be in accordance with NEC, ANSI/NFPA 70.

28.3 Transformer

A wire-in transformer should be used. Use the Model 322 wire-in 16 VAC 56 VA transformer or Model 327 plug-in 16 VAC 50 VA transformer installed inside an ES501 Enclosure with all wiring in conduit. The transformer must be mounted within 20 feet of the panel and connected by conduit.

28.4 End-of-Line Resistor

The DMP Model 310 1k Ohm EOL resistor should be used on all 1k Ohm EOL fire zones.

28.5 System Trouble Display

The Status List Display must include at least one keypad that displays system monitor troubles. See the XR500 Series Programming Guide (LT-0679).

28.6 Fire Display

The Status List Display must include at least one keypad that displays troubles and alarms on fire type zones. See the XR500 Series Programming Guide (LT-0679).

28.7 Police Station Phone Number

The digital dialer telephone number programmed for communication must not be a police station phone number, unless that phone number is specifically provided for that purpose.

28.8 System Maintenance

To ensure continuous satisfactory operation of any alarm system, proper installation and regular maintenance by the installing alarm company and frequent testing by the end user is essential. Offering a maintenance program and acquainting the user with the correct procedures for system use and testing is also the responsibility of the installing alarm company.

28.9 Audible Alarm

Fire Type zones should be programmed to activate an audible alarm. The Bell Action for Fire Type zones should not be programmed as "N". See the XR500 Series Programming Guide (LT-0679).

28.10 Fire Zone Programming

If a retard delay is used on a waterflow zone, it cannot exceed 90 seconds and any retard delay in the waterflow initiating devices must be subtracted from the 90 seconds allowed. See the XR500 Series Programming Guide (LT-0679). The retard delay should not be used on a zone with smoke detectors.

28.11 Style D Zones

If required, the DMP 869 Dual Style D Initiating Module provides for connection of two Style D zones to the Model XR500 Series. See the 869 Installation Guide (LT-0186) and sections 20.2 and 28.2 of this guide for wiring information.

28.12 Video Option

The Video option must be selected as NO when any fire protection is connected to the XR500 Series. See the XR500 Series Programming Guide (LT-0679).

28.13 UL Listed Receivers

Use the DMP SCS-1/SCS-1R (SDLC), Sur-Gard SG-HLR2-DG (CID), FBII CP220PB (CID), and Osborne-Hoffman Quick-Alert (CID) receivers.

UL 864 NFPA 72 (Chapter 9) Specifications

Control Units for Fire-Protective Signaling Systems

29.1 Zone Restoral Reports

The Restoral Reports option must be selected as YES or Disarm. See the XR500 Series Programming Guide (LT-0679).

29.2 Power Fail Delay

The Power Fail Delay option must be selected as required by the service of the panel. For Central Station service: 6-12, for Remote Station service: 12-15. See the XR500 Series Programming Guide (LT-0679).

29.3 Sprinkler Supervisory

Any zone used for sprinkler supervisory must be programmed with "SPRINKLR XXX" as the zone name. The last three characters in the zone name may be assigned a number to identify the zone. The Model 893A Dual Phone Line Module must be used on all sprinkler supervisory systems.

29.4 DACT Systems

Two phone lines must be used. The two phone lines cannot be ground start or party lines. The 893A Dual Phone Line Module is used to provide two phone line connections to the system. The 2ND Phone Line communication option must be selected as DD. See the XR500 Series Programming Guide (LT-0679).

Two different phone numbers must be programmed for digital communication. See the XR500 Series Programming Guide (LT-0679). The Test Time option must be programmed so that the XR500 Series sends a report every 24 hours. See the XR500 Series Programming Guide (LT-0679).

29.5 Local Protective Signaling Systems

The DMP Model 865, 866, or 867 Notification Circuit Module must be used on the bell circuit for detection of shorts and grounds. See sections 32.1 to 32.2 in this guide for wiring diagrams. Model 790 series keypads that are used to display troubles for local fire alarm systems must be installed within a DMP Model 777 with 777S 1.0" spacer. Any burglary or other off premises communication must be done with the Model 893A Dual Phone Line Module. For local commercial fire installations, the 893A is required.

29.6 Remote Station Protective Signaling Systems

You must provide 60 hours of standby battery. See section 6.9 in this guide for standby battery calculations. Two Radionics Model D127 Reversing Relay Modules provide two reversing polarity telephone connections. See the D127 Installation Instruction sheet for wiring details. A DMP Model 893A is used to provide two line dialer communication.

29.7 Fire Protective Signaling Systems using Internet/Intranet Networks

The XR500 Series Command Processor™ Panel must be programmed as described below for Fire Protective Signaling Systems using NET Communication Type or an iCOM™ Network Alarm Router for communication. Refer to the iCOM™ Network Alarm Router Installation Sheet (LT-0587) for more information.

- UL AA must be programmed as NO
- SUB CODE must be programmed as YES
- CHECKIN must be programmed as 1
- RETRY TIME must be programmed as 1
- FAIL TIME must be programmed as 1
- NET TRBL must be programmed as YES

UL 985 NFPA 72 (Chapter 2) Specifications

Household Fire Warning System Units

30.1 Bell Output Definition

The Model XR500 Series panel Bell Output must be programmed to operate steady on burglary alarms and pulsed or temporal on fire alarms. See the XR500 Series Programming Guide (LT-0679).

30.2 Audible Devices

At least one listed audible device rated to operate over the voltage rate of 11.7 VDC to 12.8 VDC and rated at 85 DB minimum must be used.

30.3 Auxiliary Circuits

At least one fire alarm initiating device shall be used on the system. If the voltage for the device is applied by the control unit the fire alarm initiating device shall be rated to operate over the range of 11.5 VDC to 12.7 VDC.

30.4 Bell Cutoff

The Bell Cutoff time cannot be less than five minutes. See the XR500 Series Programming Guide (LT-0679).

California State Fire Marshal Specifications

31.1 Bell Output Definition

The Model XR500 Series panel Bell Output must be programmed to operate steady on burglary alarms and pulsed, temporal, or California School Code on fire alarms. See the XR500 Series Programming Guide (LT-0679).

Wiring Diagrams

32.1 Multiple Notification Circuit Modules

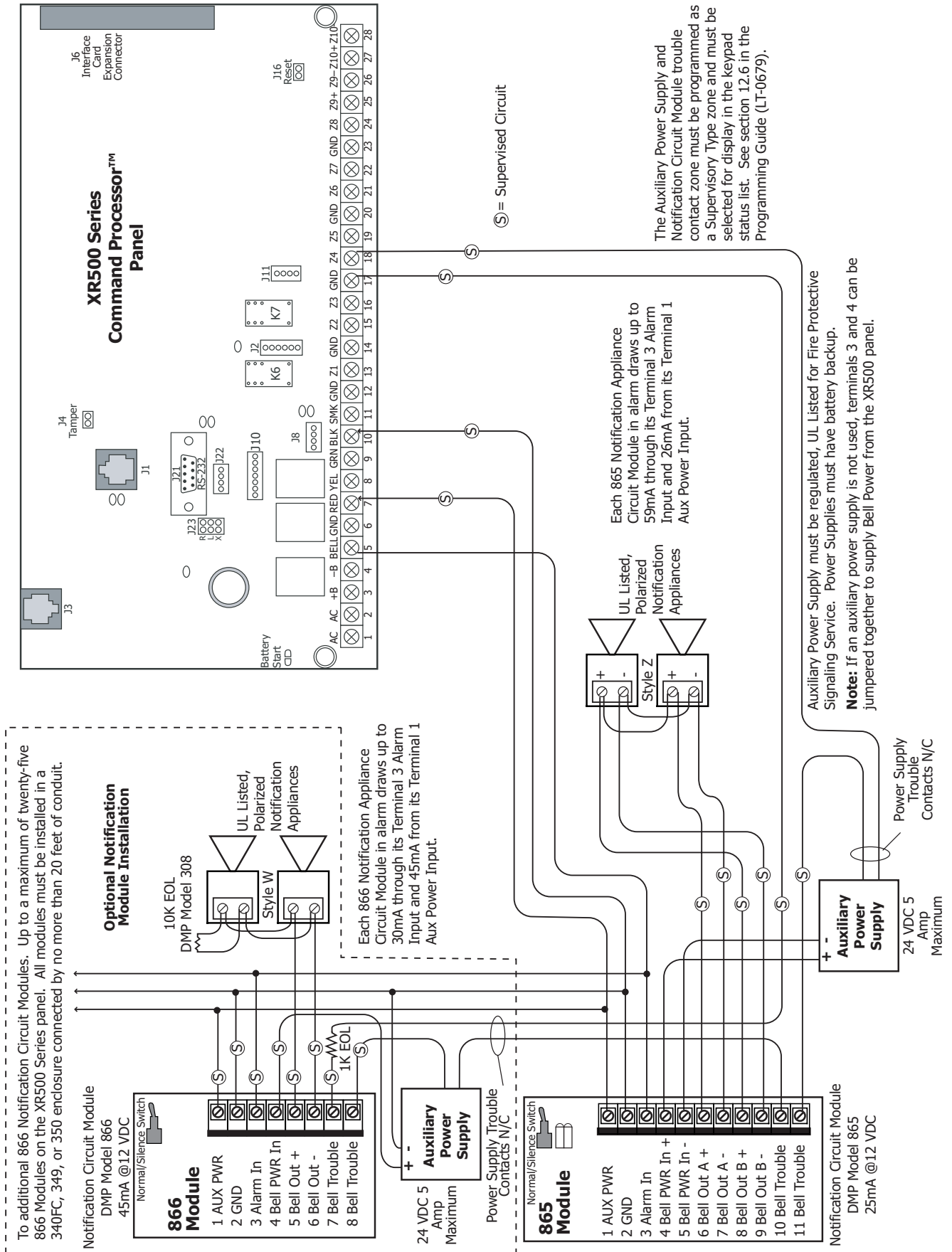

32.2 Multiple Notification Circuit Modules for Zoned Annunciation

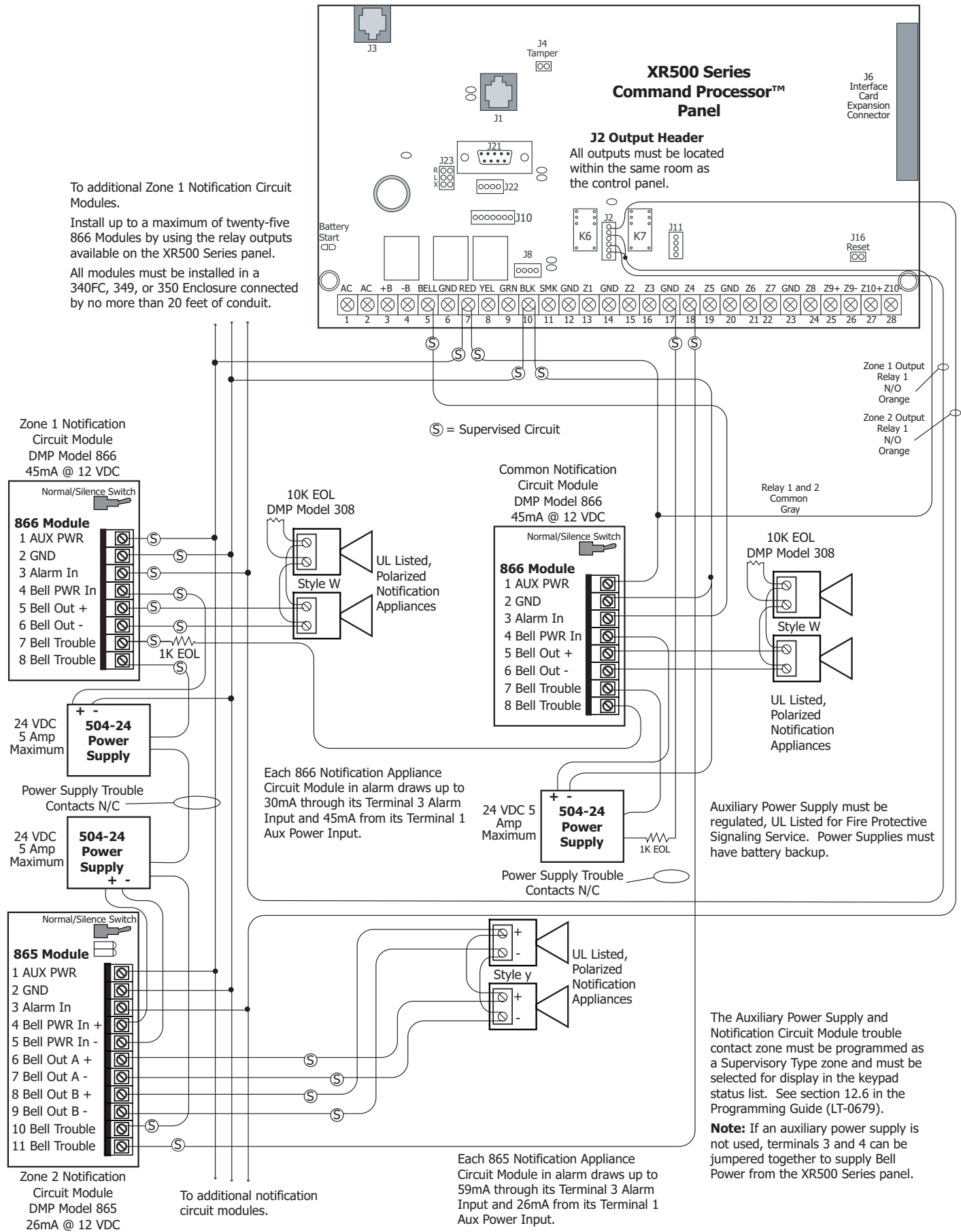

32.3 Dual Style D Zone Module Installation

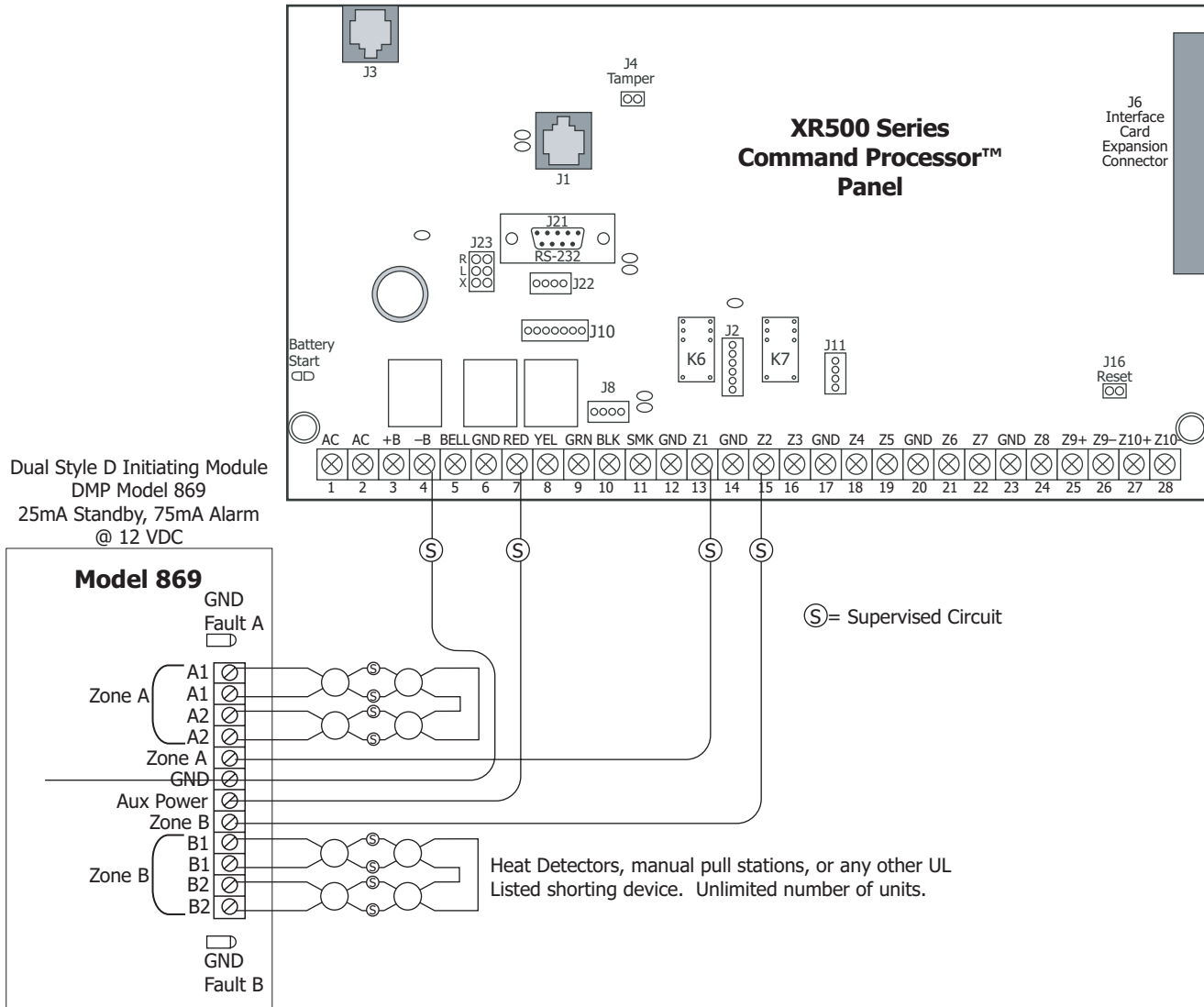

32.4 Cellular Backup Installation for Derived Channel Burglary

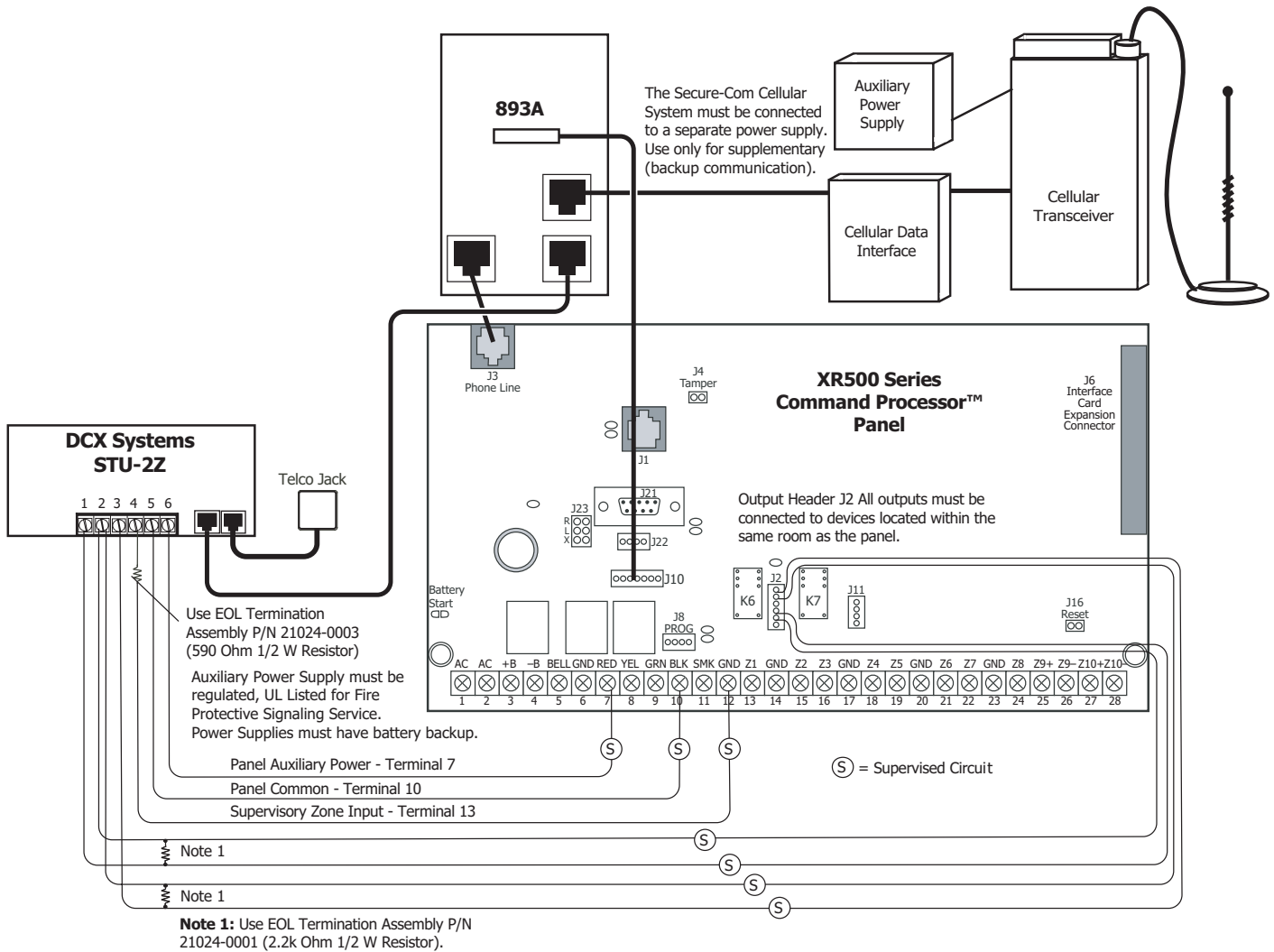

INTERFACING STU-2Z/STU-4Z TO THE XR500 SERIES PANELS

The STU-2Z or STU-4Z may only be used in conjunction with telephone systems that support DCX Systems Derived Channel multiplex network. The STU-2Z or STU-4Z can only be installed in a DMP Model 350 enclosure.

Burglary

The STU-2Z and STU-4Z are cross listed with the XR500 Series panels as an accessory for Grade AA Central Station Burglar Alarm. For Grade AA, the following conditions must be met:

- The panel must be installed and programmed to meet Grade A burglary alarm system requirements.
- The panel must be installed and programmed for reporting all alarm conditions through the integral DACT to the same central station that monitors the STU-2Z or STU-4Z.
- The STU-2Z or STU-4Z must be mounted in the panel enclosure and wired according to Section 32.4 above.
- Once installed, the central station must enable 2-minute off-hook polling of the STU-2Z or STU-4Z.

Supplementary Reporting (for Commercial Burglar Alarm Applications)

The two zones of the STU-2Z or the four zones of the STU-4Z may be used for supplementary reporting by meeting the following requirements.

1. Program Relay Output #1 for all alarm conditions that are required to report alarm on Zone 1 of the STU-2Z or STU-4Z.
2. Program Relay Output #2 for all alarm conditions that are required to report alarm on Zone 2 of the STU-2Z or STU-4Z.

3. Wire the normally-open terminals of Relay Output #1 to Terminal 1 of the STU-2Z or STU-4Z.
4. Wire the common terminal of Relay Output #1 to Terminal 2 of the STU-2Z or STU-4Z.
5. Wire the normally-open terminal of Relay Output #2 to Terminal 3 of the STU-2Z or STU-4Z.
6. Wire the common terminal of Relay Output #2 to Terminal 2 of the STU-2Z or STU-4Z.

Commercial Fire

When the XR500 Series panel is used as a Central Station Alarm Commercial Fire System with one telephone line, in conjunction with DCX Systems STU-2Z or STU-4Z, the following conditions must be met:

- The panel must be installed and programmed to meet commercial fire (reporting) systems requirements.
- The panel must be installed and programmed for reporting all alarm conditions and trouble conditions to the same central station that monitors the STU-2Z or STU-4Z.
- The STU-2Z or STU-4Z must be mounted in the panel enclosure and wired according to Section 32.4 above.
- Once installed, the central station must enable 2-minute off-hook polling of the STU-2Z or STU-4Z.

Installing the STU-2Z/STU-4Z into the DMP Model 350 Enclosure

The STU board is mounted in the left side of the DMP Model 350 enclosure by slipping the optional corner mounting bracket over the edge of the enclosure. Use DCX Part # 27074-002 (2Z) or Part # 27078-001 (4Z). Connect the STU power wires and telco cables to the panel terminals and RJ31X as shown in Section 32.4 above.

32.5 Rothenbuhler 5110 High Security Bell Wiring

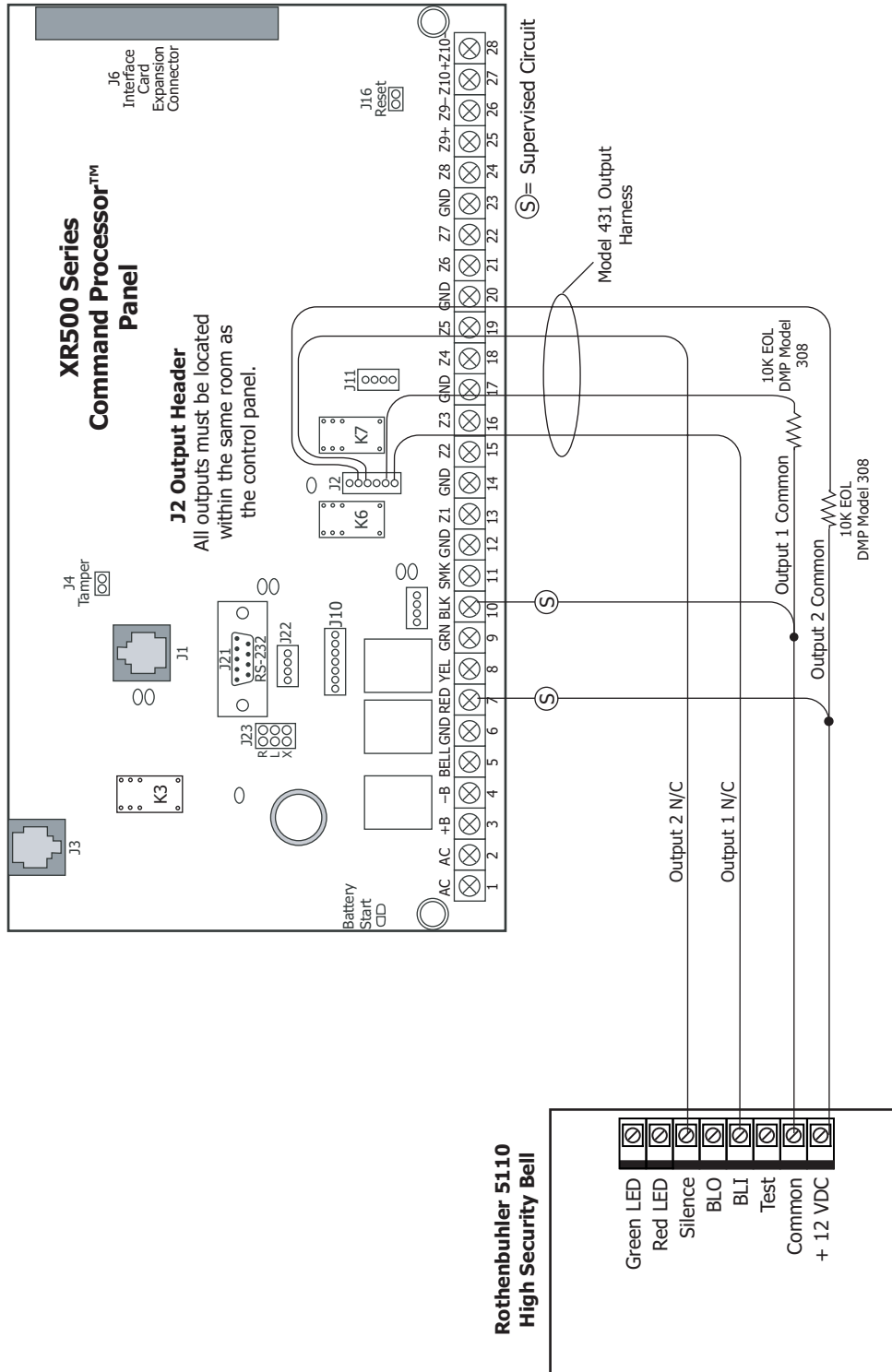

32.6 LX-Bus™ Module Connection

LX-Bus Expansion Interface Card
DMP Models 481, 462N, 462P, 462FM, or 472

Auxiliary Power Supply must be regulated (12 VDC Nominal), UL Listed for Fire Protective Signaling Service. Power Supplies must have battery backup and be power limited.

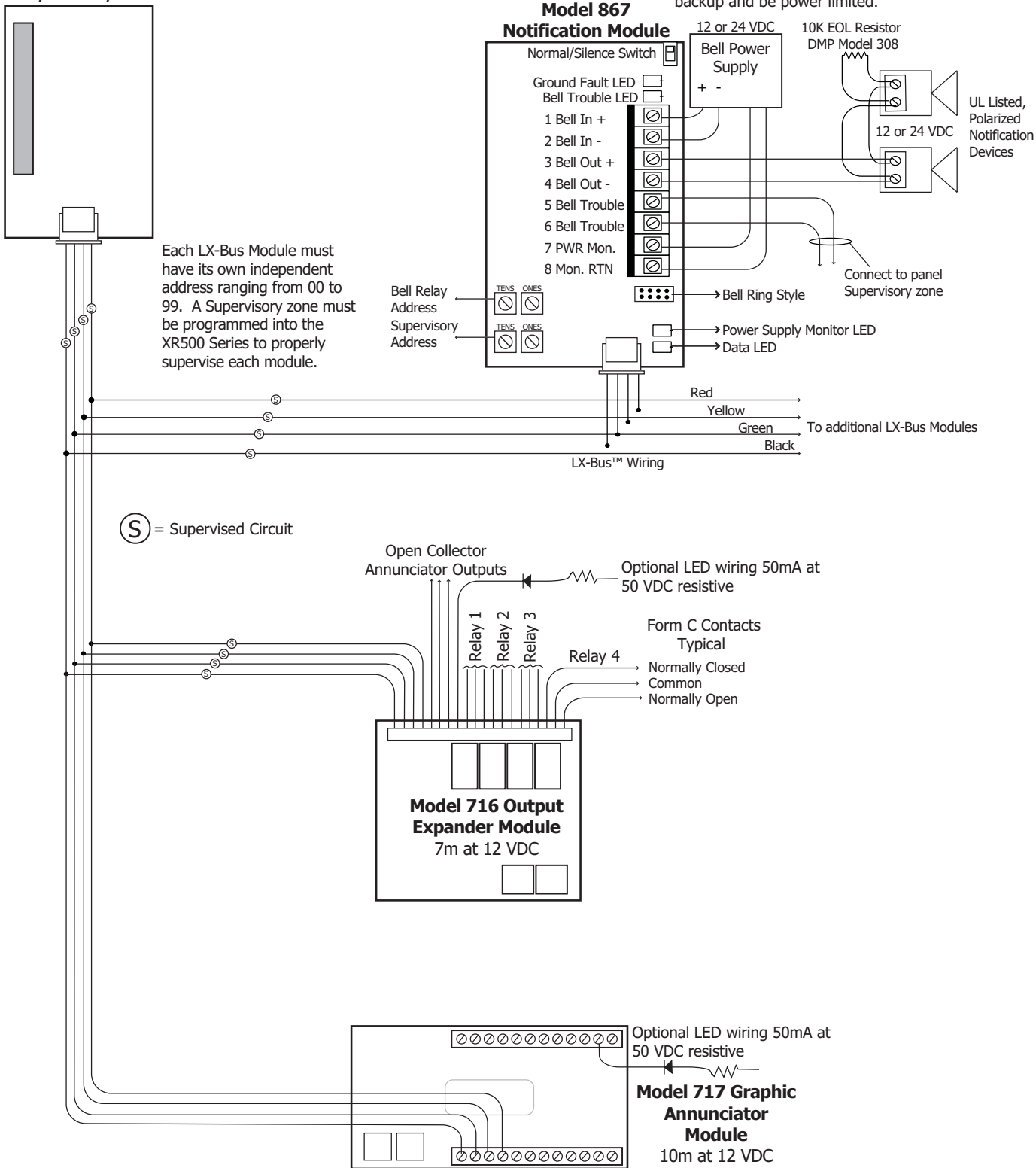

32.7 Model 860 Relay Module Connection

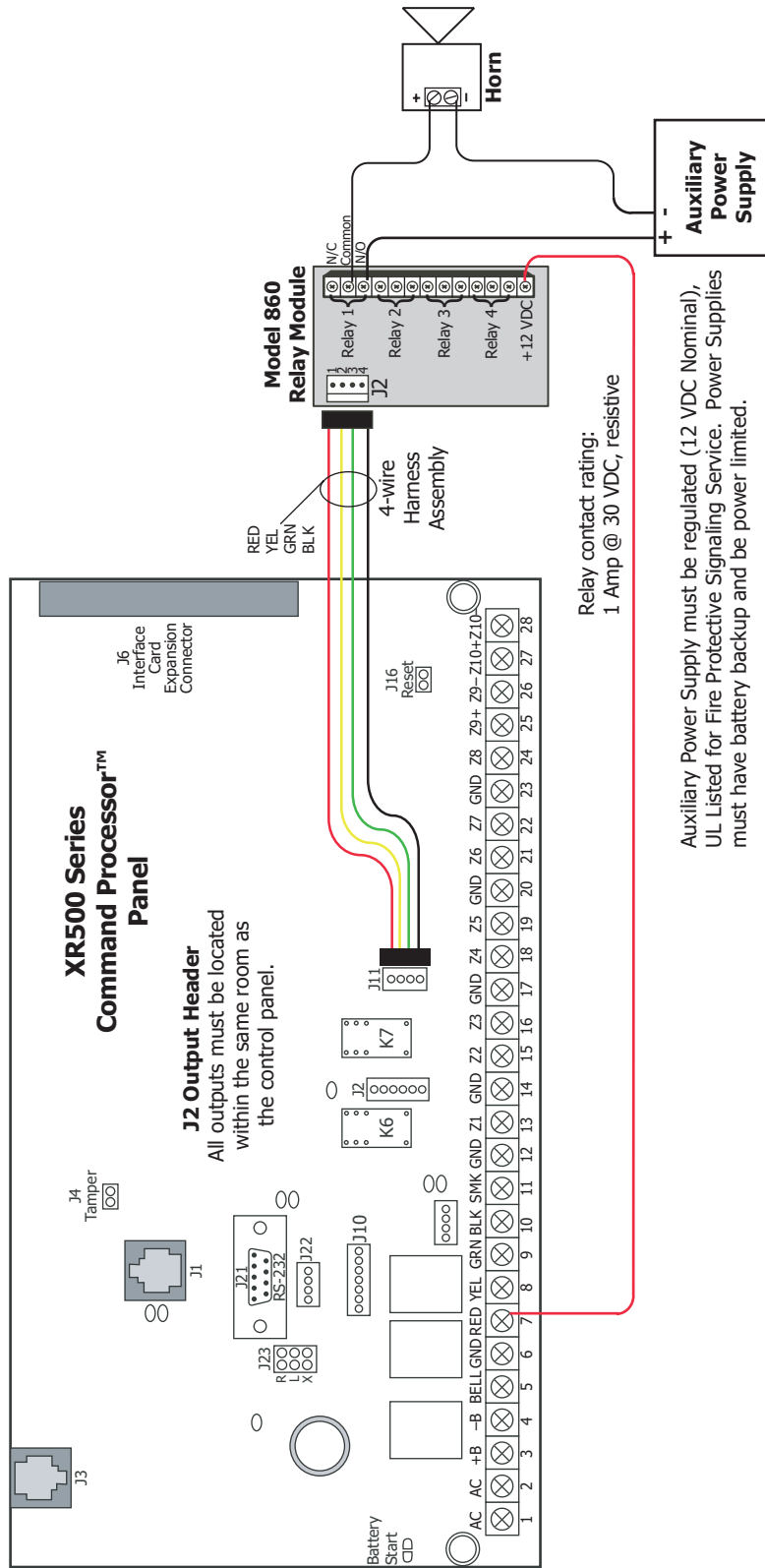

This page intentionally left blank.

Access Control Devices

733 Wiegand Interface Module
734 Wiegand Interface Module
793 Easy Entry™ Keypads
7063 and 7073 Thinline Keypads
570/575 Easy Entry™ Wireless
Receiver and Transmitter
DMP and HID Proximity Readers and Credentials

Listings and Approvals

Underwriters Laboratories (UL) Listed

- UL 294 Access Control System Units
- UL 365 Police Connected Burglar
- UL 609 Local Burglar
- UL 1023 Household Burglar
- UL 1076 Proprietary Burglar
- UL 1610 Central Station Burglar
- UL 1635 Digital Burglar
- UL 985 Household Fire Warning
- UL 864 Fire Protective Signaling

UL Bank, Safe, and Vault

UL Encrypted High Line Security

Underwriters Laboratories Canada (ULC) Listed

- UL 985 Household Fire Warning
- UL 1023 Household Burglar
- UL 1076 Proprietary Burglar
- UL 1610 Central Station Burglar
- UL 1635 Digital Burglar

NIST Validated XR500E Encrypted Command Processor Panel
Certificate #130

California State Fire Marshal (CSFM)

FCC Part 15

FCC Part 68 Registration ID CCKAL00BXR500



Digital Monitoring Products

800-641-4282

www.dmp.com

Made in the USA

INTRUSION • FIRE • ACCESS • NETWORKS

2500 North Partnership Boulevard

Springfield, Missouri 65803-8877